

Alçak Gerilim Ürünleri Fiyat Listesi

Sizin için en güvenilir
Elektrik Teması



CHINT

Müşteri Destek Hattı

0216 620 80 90

www.chint.com.tr

sales@chint.com.tr

Başlık	Syf.No.
Otomatik Sigortalar	2-7
Kaçak Akım Röleleri	8
Aydınlatma Kontaktörü	8
Zaman Rölesi	8
Kombine Çözüm	9
Kompanzasyon Ürünleri	9
Devre Kesiciler	10-13
Kaçak Akım Rölesi	16
Açık Tip Devre Kesiciler	16
Sigortalı Ayırıcılar	17-18
Mini Kontaktörler	18
Midi Kontaktörler	19-20
Maksi Kontaktörler	21
Motor Koruma Şalteri	22
Yüksek Akım Kapasitesi	23
Kutulu Yolverici	24
Buton ve Sinyal	25-26
Esnek Çözüm	27
NP8 Serisi Yeni Nesil Sinyal ve Butonlar	28

ÖNEMLİ NOTLAR

- Fiyatlarımıza her an ihbara gerek duymaksızın değişiklik yapma hakkımız saklıdır.
- Teslim tarihindeki liste fiyatlarımız faturalamaya esastır.
- Fiyatlarımıza KDV dahil değildir.
- Listemiz dışındaki ürünler için tarafımızla temasa geçiniz.
- Resimler ve teknik veriler sadece bilgi amaçlıdır.
- Uygulamalarınızda kullanım kılavuzlarına riayet ediniz.
- Tüm fiyatlarımız depomuz teslimidir.

Chint ürünleri aşağıdaki uluslararası sertifikalara sahiptir.





eB Serisi Otomatik Sigortalar



Tek giriş/çıkış
Yalın tasarım
Sağlam terminal yapısı



Ürün Tanımı 230/400 V AC 50/60 Hz	Sipariş Kodu	Fiyat (TL)	Minumum Sipariş Adeti
1 Kutup			
eB Serisi 1 Kutup 4.5 kA B eğrisi 1 A	981811	5.32	12
eB Serisi 1 Kutup 4.5 kA B eğrisi 2 A	981912	5.32	12
eB Serisi 1 Kutup 4.5 kA B eğrisi 3 A	981913	5.32	12
eB Serisi 1 Kutup 4.5 kA B eğrisi 4 A	981914	5.32	12
eB Serisi 1 Kutup 4.5 kA B eğrisi 6 A	981916	5.32	12
eB Serisi 1 Kutup 4.5 kA B eğrisi 10 A	981917	3.59	12
eB Serisi 1 Kutup 4.5 kA B eğrisi 16 A	981919	3.59	12
eB Serisi 1 Kutup 4.5 kA B eğrisi 20 A	981920	3.59	12
eB Serisi 1 Kutup 4.5 kA B eğrisi 25 A	981921	3.59	12
eB Serisi 1 Kutup 4.5 kA B eğrisi 32 A	981922	3.92	12
eB Serisi 1 Kutup 4.5 kA B eğrisi 40 A	981923	4.99	12
eB Serisi 1 Kutup 4.5 kA B eğrisi 50 A	981924	6.00	12
eB Serisi 1 Kutup 4.5 kA B eğrisi 63 A	981926	6.61	12
2 Kutup			
eB Serisi 2 Kutup 4.5 kA B eğrisi 1 A	981956	16.80	6
eB Serisi 2 Kutup 4.5 kA B eğrisi 2 A	981957	16.80	6
eB Serisi 2 Kutup 4.5 kA B eğrisi 3 A	981958	16.80	6
eB Serisi 2 Kutup 4.5 kA B eğrisi 4 A	981959	16.80	6
eB Serisi 2 Kutup 4.5 kA B eğrisi 6 A	981960	16.80	6
eB Serisi 2 Kutup 4.5 kA B eğrisi 10 A	981961	13.22	6
eB Serisi 2 Kutup 4.5 kA B eğrisi 16 A	981962	13.22	6
eB Serisi 2 Kutup 4.5 kA B eğrisi 20 A	981965	13.22	6
eB Serisi 2 Kutup 4.5 kA B eğrisi 25 A	981966	13.22	6
eB Serisi 2 Kutup 4.5 kA B eğrisi 32 A	981967	13.83	6
eB Serisi 2 Kutup 4.5 kA B eğrisi 40 A	981968	16.11	6
eB Serisi 2 Kutup 4.5 kA B eğrisi 50 A	981969	16.34	6
eB Serisi 2 Kutup 4.5 kA B eğrisi 63 A	981971	17.48	6
3 Kutup			
eB Serisi 3 Kutup 4.5 kA B eğrisi 1 A	982001	23.33	4
eB Serisi 3 Kutup 4.5 kA B eğrisi 2 A	982002	23.33	4
eB Serisi 3 Kutup 4.5 kA B eğrisi 3 A	982003	23.33	4
eB Serisi 3 Kutup 4.5 kA B eğrisi 4 A	982004	23.33	4
eB Serisi 3 Kutup 4.5 kA B eğrisi 6 A	982006	23.33	4
eB Serisi 3 Kutup 4.5 kA B eğrisi 10 A	982007	15.64	4
eB Serisi 3 Kutup 4.5 kA B eğrisi 16 A	982009	15.64	4
eB Serisi 3 Kutup 4.5 kA B eğrisi 20 A	982010	15.64	4
eB Serisi 3 Kutup 4.5 kA B eğrisi 25 A	982011	15.64	4
eB Serisi 3 Kutup 4.5 kA B eğrisi 32 A	982012	18.03	4
eB Serisi 3 Kutup 4.5 kA B eğrisi 40 A	982013	22.88	4
eB Serisi 3 Kutup 4.5 kA B eğrisi 50 A	982014	27.28	4
eB Serisi 3 Kutup 4.5 kA B eğrisi 63 A	982016	30.40	4
4 Kutup			
eB Serisi 4 Kutup 4.5 kA B eğrisi 1 A	982046	33.52	3
eB Serisi 4 Kutup 4.5 kA B eğrisi 2 A	982047	33.52	3
eB Serisi 4 Kutup 4.5 kA B eğrisi 3 A	982048	33.52	3
eB Serisi 4 Kutup 4.5 kA B eğrisi 4 A	982049	33.52	3
eB Serisi 4 Kutup 4.5 kA B eğrisi 6 A	982051	33.52	3
eB Serisi 4 Kutup 4.5 kA B eğrisi 10 A	982052	25.61	3
eB Serisi 4 Kutup 4.5 kA B eğrisi 16 A	982054	25.61	3
eB Serisi 4 Kutup 4.5 kA B eğrisi 20 A	982055	25.61	3
eB Serisi 4 Kutup 4.5 kA B eğrisi 25 A	982056	25.61	3
eB Serisi 4 Kutup 4.5 kA B eğrisi 32 A	982057	26.60	3
eB Serisi 4 Kutup 4.5 kA B eğrisi 40 A	982058	27.82	3
eB Serisi 4 Kutup 4.5 kA B eğrisi 50 A	982059	34.58	3
eB Serisi 4 Kutup 4.5 kA B eğrisi 63 A	982061	38.15	3

eB Serisi Otomatik Sigortalar

IEC IEC/EN60898-1



Tek giriş/çıkış
Yalın tasarım
Sağlam terminal yapısı

Ürün Tanımı 230/400 V AC 50/60 Hz	Sipariş Kodu	Fiyat (TL)	Minimum Sipariş Adeti
1 Kutup			
eB Serisi 1 Kutup 4.5 kA C eğrisi 1 A	982091	5.32	12
eB Serisi 1 Kutup 4.5 kA C eğrisi 2 A	982092	5.32	12
eB Serisi 1 Kutup 4.5 kA C eğrisi 3 A	982093	5.32	12
eB Serisi 1 Kutup 4.5 kA C eğrisi 4 A	982094	5.32	12
eB Serisi 1 Kutup 4.5 kA C eğrisi 6 A	982096	5.32	12
eB Serisi 1 Kutup 4.5 kA C eğrisi 10 A	982097	3.59	12
eB Serisi 1 Kutup 4.5 kA C eğrisi 16 A	982099	3.59	12
eB Serisi 1 Kutup 4.5 kA C eğrisi 20 A	982100	3.59	12
eB Serisi 1 Kutup 4.5 kA C eğrisi 25 A	982101	3.59	12
eB Serisi 1 Kutup 4.5 kA C eğrisi 32 A	982102	3.92	12
eB Serisi 1 Kutup 4.5 kA C eğrisi 40 A	982103	4.99	12
eB Serisi 1 Kutup 4.5 kA C eğrisi 50 A	982104	6.00	12
eB Serisi 1 Kutup 4.5 kA C eğrisi 63 A	982106	6.61	12
2 Kutup			
eB Serisi 2 Kutup 4.5 kA C eğrisi 1 A	982136	16.80	6
eB Serisi 2 Kutup 4.5 kA C eğrisi 2 A	982137	16.80	6
eB Serisi 2 Kutup 4.5 kA C eğrisi 3 A	982138	16.80	6
eB Serisi 2 Kutup 4.5 kA C eğrisi 4 A	982139	16.80	6
eB Serisi 2 Kutup 4.5 kA C eğrisi 6 A	982141	16.80	6
eB Serisi 2 Kutup 4.5 kA C eğrisi 10 A	982142	13.22	6
eB Serisi 2 Kutup 4.5 kA C eğrisi 16 A	982144	13.22	6
eB Serisi 2 Kutup 4.5 kA C eğrisi 20 A	982145	13.22	6
eB Serisi 2 Kutup 4.5 kA C eğrisi 25 A	982146	13.22	6
eB Serisi 2 Kutup 4.5 kA C eğrisi 32 A	982147	13.83	6
eB Serisi 2 Kutup 4.5 kA C eğrisi 40 A	982148	16.11	6
eB Serisi 2 Kutup 4.5 kA C eğrisi 50 A	982149	16.34	6
eB Serisi 2 Kutup 4.5 kA C eğrisi 63 A	982151	17.48	6
3 Kutup			
eB Serisi 3 Kutup 4.5 kA C eğrisi 1 A	982181	23.33	4
eB Serisi 3 Kutup 4.5 kA C eğrisi 2 A	982182	23.33	4
eB Serisi 3 Kutup 4.5 kA C eğrisi 3 A	982183	23.33	4
eB Serisi 3 Kutup 4.5 kA C eğrisi 4 A	982184	23.33	4
eB Serisi 3 Kutup 4.5 kA C eğrisi 6 A	982186	23.33	4
eB Serisi 3 Kutup 4.5 kA C eğrisi 10 A	982187	15.64	4
eB Serisi 3 Kutup 4.5 kA C eğrisi 16 A	982189	15.64	4
eB Serisi 3 Kutup 4.5 kA C eğrisi 20 A	982190	15.64	4
eB Serisi 3 Kutup 4.5 kA C eğrisi 25 A	982191	15.64	4
eB Serisi 3 Kutup 4.5 kA C eğrisi 32 A	982192	18.03	4
eB Serisi 3 Kutup 4.5 kA C eğrisi 40 A	982193	22.88	4
eB Serisi 3 Kutup 4.5 kA C eğrisi 50 A	982194	27.28	4
eB Serisi 3 Kutup 4.5 kA C eğrisi 63 A	982196	30.40	4
4 Kutup			
eB Serisi 4 Kutup 4.5 kA C eğrisi 1 A	982226	33.52	3
eB Serisi 4 Kutup 4.5 kA C eğrisi 2 A	982227	33.52	3
eB Serisi 4 Kutup 4.5 kA C eğrisi 3 A	982228	33.52	3
eB Serisi 4 Kutup 4.5 kA C eğrisi 4 A	982229	33.52	3
eB Serisi 4 Kutup 4.5 kA C eğrisi 6 A	982231	33.52	3
eB Serisi 4 Kutup 4.5 kA C eğrisi 10 A	982232	25.61	3
eB Serisi 4 Kutup 4.5 kA C eğrisi 16 A	982234	25.61	3
eB Serisi 4 Kutup 4.5 kA C eğrisi 20 A	982235	25.61	3
eB Serisi 4 Kutup 4.5 kA C eğrisi 25 A	982236	25.61	3
eB Serisi 4 Kutup 4.5 kA C eğrisi 32 A	982237	26.60	3
eB Serisi 4 Kutup 4.5 kA C eğrisi 40 A	982238	27.82	3
eB Serisi 4 Kutup 4.5 kA C eğrisi 50 A	982239	34.58	3
eB Serisi 4 Kutup 4.5 kA C eğrisi 63 A	982241	38.15	3





NB1 Serisi Otomatik Sigortalar



IEC/EN60898-1

Hem bara hem kablo giriş çıkış
Her fazda indikatör
Zengin aksesuar
Terminallerde soğutucu tasarım
Uzayabilen DIN ray tutucular
Denizcilik (DNV) sertifikalı

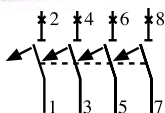
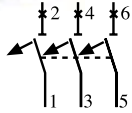
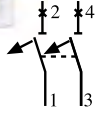

Ürün Tanımı 230/400 V AC 50/60 Hz	Sipariş Kodu	Fiyat (TL)	Minumum Sipariş Adeti
--------------------------------------	--------------	------------	--------------------------

1 Kutup

NB1 Serisi 1 Kutup 6 kA B eğrisi 1 A	971612	8.71	12
NB1 Serisi 1 Kutup 6 kA B eğrisi 2 A	971613	8.71	12
NB1 Serisi 1 Kutup 6 kA B eğrisi 3 A	971614	8.71	12
NB1 Serisi 1 Kutup 6 kA B eğrisi 4 A	971615	8.71	12
NB1 Serisi 1 Kutup 6 kA B eğrisi 6 A	971616	6.98	12
NB1 Serisi 1 Kutup 6 kA B eğrisi 10 A	971617	6.98	12
NB1 Serisi 1 Kutup 6 kA B eğrisi 16 A	971619	6.98	12
NB1 Serisi 1 Kutup 6 kA B eğrisi 20 A	971620	6.98	12
NB1 Serisi 1 Kutup 6 kA B eğrisi 25 A	971621	6.98	12
NB1 Serisi 1 Kutup 6 kA B eğrisi 32 A	971622	9.45	12
NB1 Serisi 1 Kutup 6 kA B eğrisi 40 A	971623	11.38	12
NB1 Serisi 1 Kutup 6 kA B eğrisi 50 A	971624	11.88	12
NB1 Serisi 1 Kutup 6 kA B eğrisi 63 A	971625	12.60	12

2 Kutup

NB1 Serisi 2 Kutup 6 kA B eğrisi 1 A	971626	30.53	6
NB1 Serisi 2 Kutup 6 kA B eğrisi 2 A	971627	30.53	6
NB1 Serisi 2 Kutup 6 kA B eğrisi 3 A	971628	30.53	6
NB1 Serisi 2 Kutup 6 kA B eğrisi 4 A	971629	30.53	6
NB1 Serisi 2 Kutup 6 kA B eğrisi 6 A	971630	26.78	6
NB1 Serisi 2 Kutup 6 kA B eğrisi 10 A	971631	25.99	6
NB1 Serisi 2 Kutup 6 kA B eğrisi 16 A	971633	25.99	6
NB1 Serisi 2 Kutup 6 kA B eğrisi 20 A	971634	25.99	6
NB1 Serisi 2 Kutup 6 kA B eğrisi 25 A	971635	25.99	6
NB1 Serisi 2 Kutup 6 kA B eğrisi 32 A	971636	27.22	6
NB1 Serisi 2 Kutup 6 kA B eğrisi 40 A	971637	28.87	6
NB1 Serisi 2 Kutup 6 kA B eğrisi 50 A	971638	38.74	6
NB1 Serisi 2 Kutup 6 kA B eğrisi 63 A	971639	41.18	6

3 Kutup

NB1 Serisi 3 Kutup 6 kA B eğrisi 1 A	971640	40.16	4
NB1 Serisi 3 Kutup 6 kA B eğrisi 2 A	971641	40.16	4
NB1 Serisi 3 Kutup 6 kA B eğrisi 3 A	971642	40.16	4
NB1 Serisi 3 Kutup 6 kA B eğrisi 4 A	971643	40.16	4
NB1 Serisi 3 Kutup 6 kA B eğrisi 6 A	971644	22.47	4
NB1 Serisi 3 Kutup 6 kA B eğrisi 10 A	971645	22.47	4
NB1 Serisi 3 Kutup 6 kA B eğrisi 16 A	971647	22.47	4
NB1 Serisi 3 Kutup 6 kA B eğrisi 20 A	971648	22.47	4
NB1 Serisi 3 Kutup 6 kA B eğrisi 25 A	971649	22.47	4
NB1 Serisi 3 Kutup 6 kA B eğrisi 32 A	971650	23.69	4
NB1 Serisi 3 Kutup 6 kA B eğrisi 40 A	971651	24.28	4
NB1 Serisi 3 Kutup 6 kA B eğrisi 50 A	971652	28.12	4
NB1 Serisi 3 Kutup 6 kA B eğrisi 63 A	971653	31.20	4

4 Kutup

NB1 Serisi 4 Kutup 6 kA B eğrisi 1 A	971654	59.33	3
NB1 Serisi 4 Kutup 6 kA B eğrisi 2 A	971655	59.33	3
NB1 Serisi 4 Kutup 6 kA B eğrisi 3 A	971656	59.33	3
NB1 Serisi 4 Kutup 6 kA B eğrisi 4 A	971657	59.33	3
NB1 Serisi 4 Kutup 6 kA B eğrisi 6 A	971658	48.60	3
NB1 Serisi 4 Kutup 6 kA B eğrisi 10 A	971659	48.60	3
NB1 Serisi 4 Kutup 6 kA B eğrisi 16 A	971661	48.60	3
NB1 Serisi 4 Kutup 6 kA B eğrisi 20 A	971662	48.60	3
NB1 Serisi 4 Kutup 6 kA B eğrisi 25 A	971663	48.60	3
NB1 Serisi 4 Kutup 6 kA B eğrisi 32 A	971664	50.33	3
NB1 Serisi 4 Kutup 6 kA B eğrisi 40 A	971665	53.27	3
NB1 Serisi 4 Kutup 6 kA B eğrisi 50 A	971666	72.79	3
NB1 Serisi 4 Kutup 6 kA B eğrisi 63 A	971667	73.01	3

NB1 Serisi Otomatik Sigortalar



IEC/EN60898-1



Ürün Tanımı
230/400 V AC 50/60 Hz

Sipariş Kodu Fiyat (TL) Minimum Sipariş Adeti

1 Kutup

NB1 Serisi 1 Kutup 6 kA C eğrisi 1 A	971688	8.71	12
NB1 Serisi 1 Kutup 6 kA C eğrisi 2 A	971669	8.71	12
NB1 Serisi 1 Kutup 6 kA C eğrisi 3 A	971670	8.71	12
NB1 Serisi 1 Kutup 6 kA C eğrisi 4 A	971671	8.71	12
NB1 Serisi 1 Kutup 6 kA C eğrisi 6 A	971672	6.98	12
NB1 Serisi 1 Kutup 6 kA C eğrisi 10 A	971673	6.98	12
NB1 Serisi 1 Kutup 6 kA C eğrisi 16 A	971675	6.98	12
NB1 Serisi 1 Kutup 6 kA C eğrisi 20 A	971676	6.98	12
NB1 Serisi 1 Kutup 6 kA C eğrisi 25 A	971677	6.98	12
NB1 Serisi 1 Kutup 6 kA C eğrisi 32 A	971678	9.45	12
NB1 Serisi 1 Kutup 6 kA C eğrisi 40 A	971679	11.38	12
NB1 Serisi 1 Kutup 6 kA C eğrisi 50 A	971680	11.88	12
NB1 Serisi 1 Kutup 6 kA C eğrisi 63 A	971681	12.60	12

2 Kutup

NB1 Serisi 2 Kutup 6 kA C eğrisi 1 A	971682	30.53	6
NB1 Serisi 2 Kutup 6 kA C eğrisi 2 A	971683	30.53	6
NB1 Serisi 2 Kutup 6 kA C eğrisi 3 A	971684	30.53	6
NB1 Serisi 2 Kutup 6 kA C eğrisi 4 A	971685	30.53	6
NB1 Serisi 2 Kutup 6 kA C eğrisi 6 A	971686	26.78	6
NB1 Serisi 2 Kutup 6 kA C eğrisi 10 A	971687	25.99	6
NB1 Serisi 2 Kutup 6 kA C eğrisi 16 A	971689	25.99	6
NB1 Serisi 2 Kutup 6 kA C eğrisi 20 A	971690	25.99	6
NB1 Serisi 2 Kutup 6 kA C eğrisi 25 A	971691	25.99	6
NB1 Serisi 2 Kutup 6 kA C eğrisi 32 A	971692	27.22	6
NB1 Serisi 2 Kutup 6 kA C eğrisi 40 A	971693	28.87	6
NB1 Serisi 2 Kutup 6 kA C eğrisi 50 A	971694	38.74	6
NB1 Serisi 2 Kutup 6 kA C eğrisi 63 A	971695	41.18	6

3 Kutup

NB1 Serisi 3 Kutup 6 kA C eğrisi 1 A	971696	40.16	4
NB1 Serisi 3 Kutup 6 kA C eğrisi 2 A	971697	40.16	4
NB1 Serisi 3 Kutup 6 kA C eğrisi 3 A	971698	40.16	4
NB1 Serisi 3 Kutup 6 kA C eğrisi 4 A	971699	40.16	4
NB1 Serisi 3 Kutup 6 kA C eğrisi 6 A	971700	22.47	4
NB1 Serisi 3 Kutup 6 kA C eğrisi 10 A	971701	22.47	4
NB1 Serisi 3 Kutup 6 kA C eğrisi 16 A	971703	22.47	4
NB1 Serisi 3 Kutup 6 kA C eğrisi 20 A	971704	22.47	4
NB1 Serisi 3 Kutup 6 kA C eğrisi 25 A	971705	22.47	4
NB1 Serisi 3 Kutup 6 kA C eğrisi 32 A	971706	23.69	4
NB1 Serisi 3 Kutup 6 kA C eğrisi 40 A	971707	24.28	4
NB1 Serisi 3 Kutup 6 kA C eğrisi 50 A	971708	28.12	4
NB1 Serisi 3 Kutup 6 kA C eğrisi 63 A	971709	31.20	4

4 Kutup

NB1 Serisi 4 Kutup 6 kA C eğrisi 1 A	971710	59.33	3
NB1 Serisi 4 Kutup 6 kA C eğrisi 2 A	971711	59.33	3
NB1 Serisi 4 Kutup 6 kA C eğrisi 3 A	971712	59.33	3
NB1 Serisi 4 Kutup 6 kA C eğrisi 4 A	971713	59.33	3
NB1 Serisi 4 Kutup 6 kA C eğrisi 6 A	971714	48.60	3
NB1 Serisi 4 Kutup 6 kA C eğrisi 10 A	971715	48.60	3
NB1 Serisi 4 Kutup 6 kA C eğrisi 16 A	971717	48.60	3
NB1 Serisi 4 Kutup 6 kA C eğrisi 20 A	971718	48.60	3
NB1 Serisi 4 Kutup 6 kA C eğrisi 25 A	971719	48.60	3
NB1 Serisi 4 Kutup 6 kA C eğrisi 32 A	971720	50.33	3
NB1 Serisi 4 Kutup 6 kA C eğrisi 40 A	971721	53.27	3
NB1 Serisi 4 Kutup 6 kA C eğrisi 50 A	971722	72.79	3
NB1 Serisi 4 Kutup 6 kA C eğrisi 63 A	971723	73.01	3

Hem bara hem kablo giriş çıkış
Her fazda indikatör
Zengin aksesuar
Terminallerde soğutucu tasarım
Uzayabilen DIN ray tutucu
Denizcilik (DNV) sertifikalı

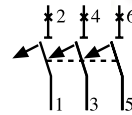
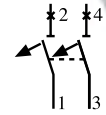



NB1 Serisi Otomatik Sigortalar



IEC/EN60898-1

Hem bara hem kablo giriş çıkış
Her fazda indikatör
Zengin aksesuar
Terminallerde soğutucu tasarım
Uzayabilen DIN ray tutucu
Denizcilik (DNV) sertifikalı

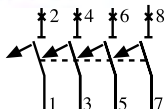
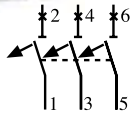
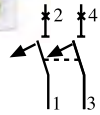

Ürün Tanımı 230/400 V AC 50/60 Hz	Sipariş Kodu	Fiyat (TL)	Minimum Sipariş Adeti
1 Kutup			
NB1 Serisi 1 Kutup 10 kA C eğrisi 1 A	971836	12.83	12
NB1 Serisi 1 Kutup 10 kA C eğrisi 2 A	971837	12.83	12
NB1 Serisi 1 Kutup 10 kA C eğrisi 3 A	971838	12.83	12
NB1 Serisi 1 Kutup 10 kA C eğrisi 4 A	971839	12.83	12
NB1 Serisi 1 Kutup 10 kA C eğrisi 6 A	971840	11.88	12
NB1 Serisi 1 Kutup 10 kA C eğrisi 10 A	971841	11.88	12
NB1 Serisi 1 Kutup 10 kA C eğrisi 16 A	971843	11.88	12
NB1 Serisi 1 Kutup 10 kA C eğrisi 20 A	971844	11.88	12
NB1 Serisi 1 Kutup 10 kA C eğrisi 25 A	971845	11.88	12
NB1 Serisi 1 Kutup 10 kA C eğrisi 32 A	971846	12.92	12
NB1 Serisi 1 Kutup 10 kA C eğrisi 40 A	971847	13.97	12
NB1 Serisi 1 Kutup 10 kA C eğrisi 50 A	971848	18.09	12
NB1 Serisi 1 Kutup 10 kA C eğrisi 63 A	971849	27.47	12
2 Kutup			
NB1 Serisi 2 Kutup 10 kA C eğrisi 1 A	971850	34.02	6
NB1 Serisi 2 Kutup 10 kA C eğrisi 2 A	971851	34.02	6
NB1 Serisi 2 Kutup 10 kA C eğrisi 3 A	971852	34.02	6
NB1 Serisi 2 Kutup 10 kA C eğrisi 4 A	971853	34.02	6
NB1 Serisi 2 Kutup 10 kA C eğrisi 6 A	971854	30.92	6
NB1 Serisi 2 Kutup 10 kA C eğrisi 10 A	971855	30.92	6
NB1 Serisi 2 Kutup 10 kA C eğrisi 16 A	971857	30.92	6
NB1 Serisi 2 Kutup 10 kA C eğrisi 20 A	971858	30.92	6
NB1 Serisi 2 Kutup 10 kA C eğrisi 25 A	971859	30.92	6
NB1 Serisi 2 Kutup 10 kA C eğrisi 32 A	971860	32.82	6
NB1 Serisi 2 Kutup 10 kA C eğrisi 40 A	971861	36.54	6
NB1 Serisi 2 Kutup 10 kA C eğrisi 50 A	971862	45.56	6
NB1 Serisi 2 Kutup 10 kA C eğrisi 63 A	971863	46.37	6
3 Kutup			
NB1 Serisi 3 Kutup 10 kA C eğrisi 1 A	971864	59.06	4
NB1 Serisi 3 Kutup 10 kA C eğrisi 2 A	971865	59.06	4
NB1 Serisi 3 Kutup 10 kA C eğrisi 3 A	971866	59.06	4
NB1 Serisi 3 Kutup 10 kA C eğrisi 4 A	971867	59.06	4
NB1 Serisi 3 Kutup 10 kA C eğrisi 6 A	971868	43.72	4
NB1 Serisi 3 Kutup 10 kA C eğrisi 10 A	971869	43.72	4
NB1 Serisi 3 Kutup 10 kA C eğrisi 16 A	971871	43.72	4
NB1 Serisi 3 Kutup 10 kA C eğrisi 20 A	971872	43.72	4
NB1 Serisi 3 Kutup 10 kA C eğrisi 25 A	971873	43.72	4
NB1 Serisi 3 Kutup 10 kA C eğrisi 32 A	971874	47.44	4
NB1 Serisi 3 Kutup 10 kA C eğrisi 40 A	971875	47.52	4
NB1 Serisi 3 Kutup 10 kA C eğrisi 50 A	971876	66.08	4
NB1 Serisi 3 Kutup 10 kA C eğrisi 63 A	971877	73.64	4
4 Kutup			
NB1 Serisi 4 Kutup 10 kA C eğrisi 1 A	971878	73.58	3
NB1 Serisi 4 Kutup 10 kA C eğrisi 2 A	971879	73.58	3
NB1 Serisi 4 Kutup 10 kA C eğrisi 3 A	971880	73.58	3
NB1 Serisi 4 Kutup 10 kA C eğrisi 4 A	971881	73.58	3
NB1 Serisi 4 Kutup 10 kA C eğrisi 6 A	971882	57.17	3
NB1 Serisi 4 Kutup 10 kA C eğrisi 10 A	971883	57.17	3
NB1 Serisi 4 Kutup 10 kA C eğrisi 16 A	971885	57.17	3
NB1 Serisi 4 Kutup 10 kA C eğrisi 20 A	971886	57.17	3
NB1 Serisi 4 Kutup 10 kA C eğrisi 25 A	971887	57.17	3
NB1 Serisi 4 Kutup 10 kA C eğrisi 32 A	971888	63.62	3
NB1 Serisi 4 Kutup 10 kA C eğrisi 40 A	971889	67.23	3
NB1 Serisi 4 Kutup 10 kA C eğrisi 50 A	971890	87.41	3
NB1 Serisi 4 Kutup 10 kA C eğrisi 63 A	971891	91.73	3

125A'e kadar güçlü sigorta ailesi

10 kA | Yavaş Karakterli

Otomatik Sigortalar

CHNT

DZ158 Serisi Otomatik Sigortalar

IEC IEC/EN60947-2



Ürün Tanımı 230/400 V AC 50/60 Hz	Sipariş Kodu	Fiyat (TL)	Minimum Sipariş Adeti
1 Kutup			
DZ158 Serisi 1 Kutup 10 kA C eğrisi 63 A	978979	34.50	12
DZ158 Serisi 1 Kutup 10 kA C eğrisi 80 A	978980	40.54	12
DZ158 Serisi 1 Kutup 10 kA C eğrisi 100 A	978981	44.86	12
DZ158 Serisi 1 Kutup 10 kA C eğrisi 125 A	985594	56.7	12
3 Kutup			
DZ158 Serisi 3 Kutup 10 kA C eğrisi 63 A	978985	120.77	4
DZ158 Serisi 3 Kutup 10 kA C eğrisi 80 A	978986	136.80	4
DZ158 Serisi 3 Kutup 10 kA C eğrisi 100 A	978987	142.70	4
DZ158 Serisi 3 Kutup 10 kA C eğrisi 125 A	985596	148.50	4
4 Kutup			
DZ158 Serisi 4 Kutup 10 kA C eğrisi 63 A	978988	175.12	4
DZ158 Serisi 4 Kutup 10 kA C eğrisi 80 A	978989	198.45	4
DZ158 Serisi 4 Kutup 10 kA C eğrisi 100 A	978990	212.62	4
DZ158 Serisi 4 Kutup 10 kA C eğrisi 125 A	985597	223.34	4
DZ Serisi Otomatik Sigortalar için yardımcı aksesuarlar			
AX-1 yardımcı Kontak Bloğu 3A, 1NA+1NK	985483	21.78	1

Güçlü yapı
Her fazda indikatör
Zengin aksesuar



NB1 Serisi Otomatik Sigortalar için yardımcı aksesuarlar

Ürün Tanımı	Sipariş Kodu	Fiyat (TL)
İlave Bloklar		
S9 açtırma Bobini 220/380 V	131406	42.32
V9 Düşük gerilim Bobini 220/380 V	131410	65.78
F9 Yardımcı Kontak Bloğu 3A 1NA+1NK	131401	25.28
F9J Alarm Kontakları 3A, 1NA+1NK	131413	30.12
Besleme Baraları		
Çatal Tip 1 Kutup 1 Metre	131501	17.35
Çatal Tip 2 Kutup 1 Metre	131502	30.15
Çatal Tip 3 Kutup 1 Metre	131503	36.71
Çatal Tip 4 Kutup 1 Metre	131504	43.12



18mm'de 2 kutuplu kesme

6 kA C | Yavaş Karakterli

Otomatik Sigortalar

CHNT

NB8 Serisi Faz + Nötr Kesmeli

IEC IEC/EN60898-1



Ürün Tanımı 230/400 V AC 50/60 Hz	Sipariş Kodu	Fiyat (TL)	Minimum Sipariş Adeti
1 Faz + Nötr			
NB8-40H Serisi 1 Kutup + Nötr 6kA 1 A	983270	33.72	12
NB8-40H Serisi 1 Kutup + Nötr 6kA 2 A	983271	33.72	12
NB8-40H Serisi 1 Kutup + Nötr 6kA 3 A	983272	33.72	12
NB8-40H Serisi 1 Kutup + Nötr 6kA 4 A	983273	33.72	12
NB8-40H Serisi 1 Kutup + Nötr 6kA 6 A	983274	18.76	12
NB8-40H Serisi 1 Kutup + Nötr 6kA 10 A	983275	15.11	12
NB8-40H Serisi 1 Kutup + Nötr 6kA 16 A	983276	15.11	12
NB8-40H Serisi 1 Kutup + Nötr 6kA 20 A	983277	15.11	12
NB8-40H Serisi 1 Kutup + Nötr 6kA 25 A	983278	16.36	12
NB8-40H Serisi 1 Kutup + Nötr 6kA 32 A	983279	17.12	12
NB8-40H Serisi 1 Kutup + Nötr 6kA 40 A	983280	21.84	12

Dar gövde
İndikatör
İşaretili nötr





NL1 Serisi Kaçak Akım Röleleri

IEC IEC/EN61008-1



Ürün Tanımı 230/400 V AC 50/60 Hz	Sipariş Kodu	Fiyat (TL)
NL1 Serisi 2 Kutup 30mA 25 A	972174	43.21
NL1 Serisi 2 Kutup 30mA 40 A	972177	43.21
NL1 Serisi 2 Kutup 30mA 63 A	972180	49.86
NL1 Serisi 2 Kutup 300mA 25 A	972176	43.21
NL1 Serisi 2 Kutup 300mA 40 A	972179	43.21
NL1 Serisi 2 Kutup 300mA 63 A	972182	49.86
NL1 Serisi 4 Kutup 30mA 25 A	972192	55.96
NL1 Serisi 4 Kutup 30mA 40 A	972195	55.96
NL1 Serisi 4 Kutup 30mA 63 A	972198	65.93
NL1 Serisi 4 Kutup 300mA 25 A	972194	55.96
NL1 Serisi 4 Kutup 300mA 40 A	972197	55.96
NL1 Serisi 4 Kutup 300mA 63 A	972200	65.93
NL1 Serisi 4 Kutup 300mA 80 A	985550	157.32
NL1 Serisi 4 Kutup 300mA 100 A	985552	174.78



NCH8 Serisi Bina İçi Aydınlatma / Otomasyon Kontaktörü

IEC IEC/EN61095



Ürün Tanımı 220/230 V AC 50/60 Hz	Sipariş Kodu	Fiyat (TL)
NCH8 Serisi 2 Kutup 20 A 2NA Kontak	981874	24.10
NCH8 Serisi 2 Kutup 40 A 4NA Kontak	981879	68.49
NCH8 Serisi 2 Kutup 60 A 4NA Kontak	981887	74.27



NTE8 Serisi LEDli Elektronik Zaman Rölesi

IEC IEC/EN6947-5-1



Ürün Tanımı 230/400 V AC 50/60 Hz	Sipariş Kodu	Fiyat (TL)
NTE8 Serisi 0.1-10 sn 5A 1NA	153401	36.23
NTE8 Serisi 10-120 sn 5A 1NA	153401	36.23
NTE8 Serisi 30-480 sn 5A 1NA	153403	36.23

NB1L Kaçak Akım Koruma Anahtarlı Otomat (6ka C)



IEC/EN60898-1



Ürün Tanımı 230/400 V AC 50/60 Hz	Sipariş Kodu	Fiyat (TL)	
NL1 Serisi 2 Kutup 30mA 6 A	971960	68.52	YENİ
NL1 Serisi 2 Kutup 30mA 10 A	971963	68.52	YENİ
NL1 Serisi 2 Kutup 30mA 16 A	971966	68.52	YENİ
NL1 Serisi 2 Kutup 30mA 20 A	971969	68.52	YENİ
NL1 Serisi 2 Kutup 30mA 25 A	971972	68.52	YENİ
NL1 Serisi 2 Kutup 30mA 32 A	971975	68.52	YENİ
NL1 Serisi 2 Kutup 30mA 40 A	971978	68.52	YENİ
NL1 Serisi 4 Kutup 300mA 10 A	972064	97.92	YENİ
NL1 Serisi 4 Kutup 300mA 16 A	972067	97.92	YENİ
NL1 Serisi 4 Kutup 300mA 20 A	972070	97.92	YENİ
NL1 Serisi 4 Kutup 300mA 25 A	972073	97.92	YENİ
NL1 Serisi 4 Kutup 300mA 32 A	972076	97.92	YENİ
NL1 Serisi 4 Kutup 300mA 40 A	972079	97.92	YENİ



Kontaktör

CJ19 Serisi Kompanzasyon Kontaktörü

IEC/EN60947-4-1



Ürün Tanımı 400/440 V AC 50/60 Hz	Sipariş Kodu	Yardımcı Katak	Fiyat (TL)
CJ19 Serisi 3 Kutup 12 kVAR	CJ19-2511	1NA + 1 NK	34.14
CJ19 Serisi 3 Kutup 18 kVAR	CJ19-3211	1NA + 1 NK	50.75
CJ19 Serisi 3 Kutup 20 kVAR	CJ19-4311	1NA + 1 NK	55.50
CJ19 Serisi 3 Kutup 30 kVAR	CJ19-6312	1NA + 2 NK	105.63
CJ19 Serisi 3 Kutup 50 kVAR	CJ19-9512	1NA + 2 NK	159.75



20 katı darbe kapasitesi
Uzun ömür
Sağlam yapı
220VAC bobinli

Son teknoloji !

Kondansatör

NWC5 Serisi Güçlendirilmiş Kondansatörler

IEC/EN60831



Ürün Tanımı	Sipariş Kodu	Fiyat (TL)
450 V AC 50/60 HZ		
NWC5 Serisi 450 V 3 Kutup 5 kVAR	NWC5-0,45-5-3	66.96
NWC5 Serisi 450 V 3 Kutup 10 kVAR	NWC5-0,45-10-3	84.92
NWC5 Serisi 450 V 3 Kutup 12 kVAR	NWC5-0,45-12-3	101.92
NWC5 Serisi 450 V 3 Kutup 15 kVAR	NWC5-0,45-15-3	127.52
NWC5 Serisi 450 V 3 Kutup 20 kVAR	NWC5-0,45-20-3	169.74
NWC5 Serisi 450 V 3 Kutup 25 kVAR	NWC5-0,45-25-3	213.17
400 V AC 50/60 HZ		
NWC5 Serisi 400 V 3 Kutup 5 kVAR	NWC5-0,40-5-3	63.78
NWC5 Serisi 400 V 3 Kutup 10 kVAR	NWC5-0,40-10-3	80.88
NWC5 Serisi 400 V 3 Kutup 12 kVAR	NWC5-0,40-12-3	97.06
NWC5 Serisi 400 V 3 Kutup 15 kVAR	NWC5-0,40-15-3	121.45
NWC5 Serisi 400 V 3 Kutup 20 kVAR	NWC5-0,40-20-3	161.66
NWC5 Serisi 400 V 3 Kutup 25 kVAR	NWC5-0,40-25-3	203.02

Son teknoloji
Metalize polipropilen film
Yenileme oranı yüksek
Süper düşük kayıp oranı < 0.0012
Gerilim dalgalanmalarına güçlü reaksiyon
1.3 katına kadar aşırı akım
Klemensli bağlantı
Dikey montaj
Yağlı tip





NM1 Serisi Ayarsız Alçak Gerilim Devre Kesicileri

IEC IEC/EN60947-2

Yüksek kesme kapasitesi
Sabit termik
Sabit manyetik 7.2In
Zengin aksesuar
Faz ayırıcıları dahil



Ürün Tanımı 400 V AC 50/60 Hz	Sipariş Kodu	Kesme Kapasitesi Icu (kA)	Termik I (A)	Fiyat (TL)
NM1-63S 3 Kutup 16 A	121002	15	16 A	125.44
NM1-63S 3 Kutup 20 A	121003	15	20 A	125.44
NM1-63S 3 Kutup 25 A	121004	15	25 A	125.44
NM1-63S 3 Kutup 32 A	121005	15	32 A	125.44
NM1-63S 3 Kutup 40 A	121006	15	40 A	125.44
NM1-63S 3 Kutup 50 A	121007	15	50 A	125.44
NM1-63S 3 Kutup 63 A	121008	15	63 A	125.44
NM1-100S 3 Kutup 80 A	121025	25	80 A	141.33
NM1-100S 3 Kutup 100 A	121026	25	100 A	141.33
NM1-225S 3 Kutup 125 A	121038	35	125 A	146.67
NM1-225S 3 Kutup 160 A	121039	35	160 A	204.43
NM1-225S 3 Kutup 200 A	121041	35	200 A	249.78
NM1-400S 3 Kutup 250 A	121050	35	250 A	302.34
NM1-400S 3 Kutup 315 A	121052	35	315 A	468.47
NM1-400S 3 Kutup 400 A	121053	35	400 A	437.24
NM1-630H 3 Kutup 500 A	121236	50	500 A	668.52
NM1-630H 3 Kutup 630 A	121237	50	630 A	867.26
NM1-800H 3 Kutup 800 A	121243	60	800 A	1508.37
NM1-1250H 3 Kutup 1000 A	121255	65	1000 A	2273.76
NM1-1250H 3 Kutup 1250 A	121256	65	1250 A	2354.82

NM1 Serisi Devre Kesiciler için Yardımcı Aksesuarlar

Ürün Tanımı	Sipariş Kodu	Fiyat (TL)
Yardımcı Kontakt (1NA/1NK)		
NM1-63S	125044	34.41
NM1-100S	125045	36.20
NM1-225 S	125046	38.72
NM1-400S	125047	81.88
NM1-630H	125049	89.47
NM1-800H	125050	102.67
NM1-1250 H	125052	123.65

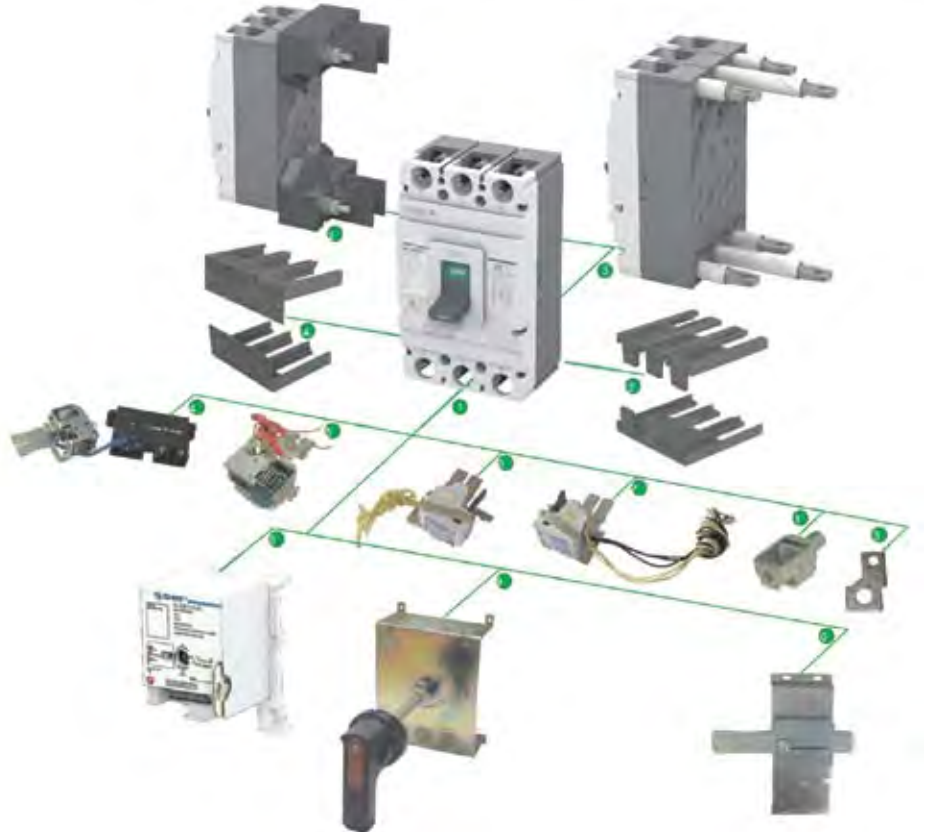

NM8 Alçak Gerilim Devre Kesicileri (3 Kutuplu)



Ürün Tanımı 400 /690 V AC	Sipariş Kodu	Kesme Kapasitesi Icu (kA)	Termik I (A)	Fiyat (TL)
Termik Manyetik Açırma Ünitesi				
NM8-125S 3 Kutup 16 A	123001	50	13-16	188.37
NM8-125S 3 Kutup 20 A	123002	50	16-20	188.37
NM8-125S 3 Kutup 25 A	123003	50	20-25	188.37
NM8-125S 3 Kutup 32 A	123004	50	26-32	188.37
NM8-125S 3 Kutup 40 A	123005	50	33-40	188.37
NM8-125S 3 Kutup 50 A	123006	50	40-50	188.37
NM8-125S 3 Kutup 63 A	123007	50	51-63	188.37
NM8-125S 3 Kutup 80 A	123008	50	64-80	188.37
NM8-125S 3 Kutup 100 A	123009	50	81-100	188.37
NM8-125S 3 Kutup 125 A	123010	50	101-125	188.37
NM8-250S 3 Kutup 160 A	123054	50	126-160	244.67
NM8-250S 3 Kutup 200 A	123055	50	161-200	299.17
NM8-250S 3 Kutup 250 A	123056	50	201-250	321.33
NM8-400S 3 Kutuplu 315 A	123086	70	252-315	649.22
NM8-400S 3 Kutuplu 400 A	123088	70	320-420	708.78
NM8-630S 3 Kutuplu 500 A	123121	70	400-500	874.21
NM8-630S 3 Kutuplu 630 A	123378	70	504-630	1125.16
NM8-800H 3 Kutuplu 800 A	123379	70	640-800	1499.68
NM8-1250H 3 Kutuplu 1000 A	123390	70	800-1000	2395.93
NM8-1250H 3 Kutuplu 1250 A	123391	70	1000-1250	2588.67

Elektronik Açırma Ünitesi

NM8-125S 3 Kutup 40 A	123041	50	16-40	430.00
NM8-125S 3 Kutup 100 A	123042	50	40-100	440.00
NM8-125S 3 Kutup 125 A	123043	50	50-125	450.00
NM8-250S 3 Kutup 160 A	123070	70	63-160	490.00
NM8-250S 3 Kutup 200 A	123071	70	80-200	570.00
NM8-250S 3 Kutup 250 A	123072	70	100-250	590.00
NM8-400S 3 Kutuplu 315 A	123102	70	126-315	958.47
NM8-400S 3 Kutuplu 400 A	123104	70	160-400	1148.47
NM8-630S 3 Kutuplu 500 A	123141	70	200-500	1303.93
NM8-630S 3 Kutuplu 630 A	123142	70	252-630	1667.54
NM8-800H 3 Kutuplu 800 A	123395	70	320-630	2144.31
NM8-1250H 3 Kutuplu 1000 A	123396	70	320-800	2943.46
NM8-1250H 3 Kutuplu 1250 A	123397	70	400-1000	3145.81

Son jenerasyon kesici
Yüksek kesme kapasitesi
Elektronik/Termik manyetik tip korumalı
Zengin aksesuar
Faz ayırıcıları dahil
Denizcilik (DNV) sertifikalı

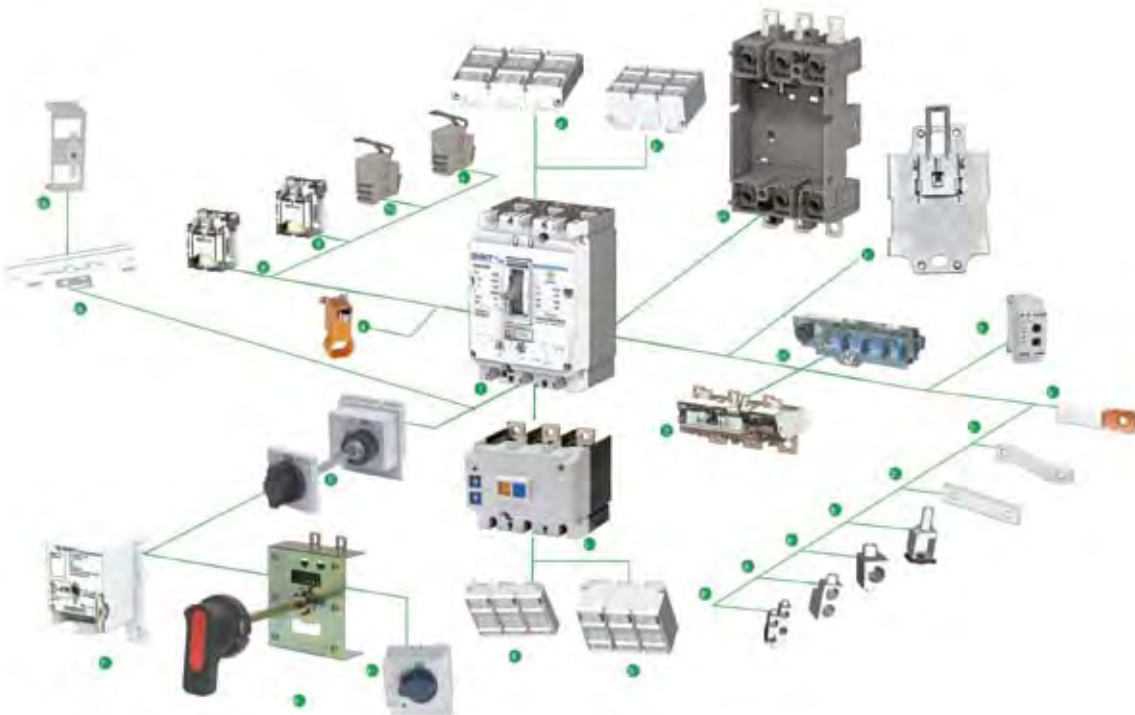



NM8 Alçak Gerilim Devre Kesicileri (4 Kutuplu)

DNV IEC/EN60947-2

Son jenerasyon kesici
Yüksek kesme kapasitesi
Elektronik/Termik manyetik tip korumalı
Zengin aksesuar
Faz ayırıcıları dahil
Denizcilik (DNV) sertifikalı

Ürün Tanımı 400 /690 V AC	Sipariş Kodu	Kesme Kapasitesi Icu (kA)	Termik I (A)	Fiyat (TL)	
NM8-125 S 4 Kutuplu 40 A	123025	50	33-40	313.85	YENİ
NM8-125 S 4 Kutuplu 50 A	123026	50	40-50	313.85	YENİ
NM8-125 S 4 Kutuplu 63 A	123027	50	51-63	313.85	YENİ
NM8-125 S 4 Kutuplu 80 A	123028	50	64-80	313.85	YENİ
NM8-125 S 4 Kutuplu 100 A	123029	50	81-100	313.85	YENİ
NM8-125 S 4 Kutuplu 125 A	123030	50	101-125	325.38	YENİ
NM8-250 S 4 Kutuplu 160 A	123062	50	126-160	457.68	YENİ
NM8-250 S 4 Kutuplu 200 A	123063	50	161-200	591.23	YENİ
NM8-250 S 4 Kutuplu 250 A	123064	50	201-250	610.35	YENİ

NM8 Alçak Gerilim Devre Kesicileri (Yüksek Kesme Kapasiteli)

Ürün Tanımı 400 /690 V AC	Sipariş Kodu	Kesme Kapasitesi Icu (kA)	Termik I (A)	Fiyat (TL)	
NM8-125H 3 kutuplu 40A	123213	100	33-40	287.82	YENİ
NM8-125H 3 kutuplu 50 A	123214	100	40-50	287.82	YENİ
NM8-125H 3 kutuplu 63 A	123215	100	51-63	287.82	YENİ
NM8-125H 3 kutuplu 80 A	123216	100	64-80	287.82	YENİ
NM8-125H 3 kutuplu 100 A	123217	100	81-100	287.82	YENİ
NM8-125H 3 kutuplu 125 A	123218	100	101-125	287.82	YENİ
NM8-250H 3 Kutuplu 160 A	123270	100	126-160	312.08	YENİ
NM8-250H 3 Kutuplu 200 A	123271	100	161-200	346.82	YENİ
NM8-250H 3 Kutuplu 250 A	123272	100	201-250	378.01	YENİ

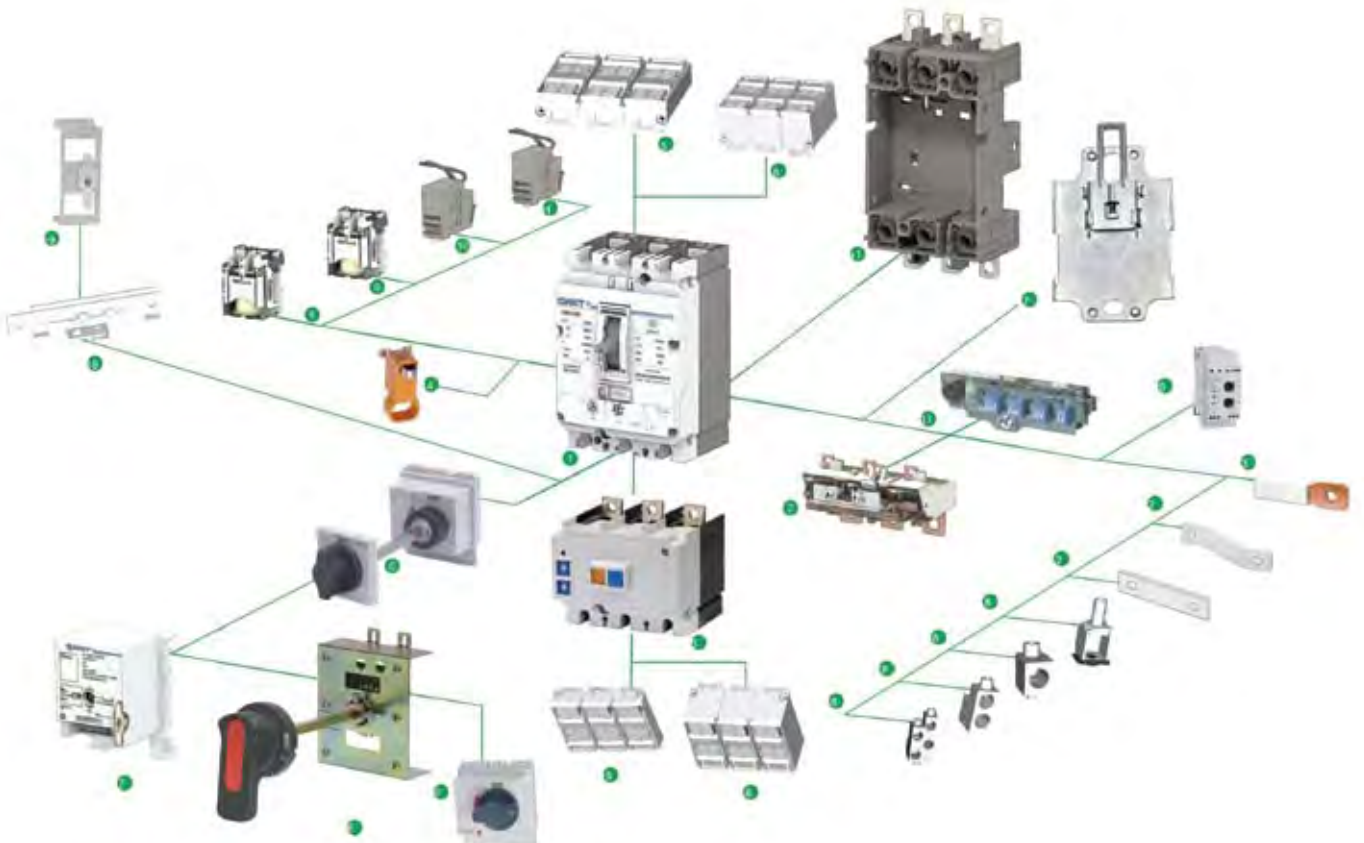

NM8 Serisi Alçak Gerilim Devre Kesici için Aksesuar



Ürün Tanımı 400 V AC	Sipariş Kodu	Besleme Gerilimi	Montaj Tipi	Fiyat (TL)
Açtırma Bobini (SM5)				
NM8-125S için	125692	220 V AC		105.84
NM8-250S,400S,630S için	125693	220 V AC		105.84
NM8-800H, 1250H için	125694	220 V AC		208.76
Düşük Gerilim Bobini (UM5)				
NM8-125S için	125702	220 V AC		141.88
NM8-250S,400S,630S için	125703	220 V AC		141.88
NM8-800H, 1250H için	125704	220 V AC		185.20
İlave Kontak (AX)				
Tüm Seriler için	125708		Sola Takılan	141.88
Tüm Seriler için	125719		Ortasına Takılan	141.88
Tüm Seriler için	125720		Sağa Takılan	185.20
Alarm Kontak (AL)				
Tüm Seriler için	125709			30.96
Motor				
NM8-125S için	125688	220 V AC veya DC		644.40
NM8-250S için	125689	220 V AC veya DC		711.92
NM8-400S,630S için	125690	220 V AC veya DC		1.512.00
NM8-1250 için	125691	220 V AC veya DC		1.814.00
Plastik Döner Kurma Kolu				
NM8-125S için	125659		Direkt Kısa Tip	123.02
NM8-250 için	125660		Direkt Kısa Tip	142.71
NM8-400 ve 630 için	125661		Direkt Kısa Tip	213.41
NM8-125S için	125662		Uzatma Kollu	149.00
NM8-250 için	125663		Uzatma Kollu	165.00
NM8-400 ve 630 için	125664		Uzatma Kollu	240.00
Metal Döner Kurma Kolu				
NM8-125S için	125655		Uzatma Kollu	103.47
NM8-250 için	125656		Uzatma Kollu	127.3
NM8-400 ve 630 için	125657		Uzatma Kollu	198.26
NM8-1250 için	125658		Uzatma Kollu	219.04
Kilit				
NM8-125S için	125671		Asma Tip	22.00
NM8-250S,400S,630S için	125672		Asma Tip	22.00
NM8-800H, 1250H için	125673		Asma Tip	30.00
Mekanik Kilit				
NM8-125S için	125710		Yatay Tip	94.00
NM8-250 için	125711		Yatay Tip	94.00
NM8-400 ve 630 için	125712		Yatay Tip	124.00
NM8-125S için	125716		Dikey Tip	184.00
NM8-250 için	125717		Dikey Tip	184.00
NM8-400 ve 630 için	125718		Dikey Tip	184.00
Çekmece Kiti (Plug In)				
NM8-125 3 Kutup	125621		Plug In	330.00
NM8-250 3 Kutup	125622		Plug In	390.00
NM8-400,630 3 Kutup	125623		Plug In	940.00
NM8-125 4 Kutup	125624		Plug In	550.00
NM8-250 4 Kutup	125625		Plug In	570.00
NM8-400,630 4 Kutup	125626		Plug In	1.250.00



Not: 4 kutuplu şalterlerle ilgili detaylar için bizden bilgi alabilirsiniz.



RDC Serisi Kaçak Akım Röleleri

IEC IEC 755/50081/50082

Otomatik/manuel
2 LED'li

Ürün Tanımı	Sipariş Kodu	Yardımcı Kontakt	Fiyat (TL)
230/400 V AC			
RDC serisi 0,03-0,5 A	RDC-07	1NA/NK	257.15
RDC serisi 0,025-25A	RDC-03	1NA/NK	434.65
TTC serisi toroid-60mm	TTC-060C		169.47
TTC serisi toroid-110mm	TTC-0110C		317.63
TTC serisi toroid-160mm	TTC-0160C		869.23
TTC serisi toroid-210mm	TTC-0210C		921.69



NA1 Serisi Açık Tip Devre Kesicileri

IEC IEC/EN60831

LED ekran
Ekrandan dijital ayar
60F ve pano çerçevesi dahil
Ampermetre
Test girişi

Ürün Tanımı	Sipariş Kodu	Kesme Kapasitesi Icu (kA)	Termik I (A)	Fiyat (TL)
400 /690 V AC				
Elektronik koruma Üniteli Sabit Tip 3 Kutuplu				
NA1-2000 630 A 3 Kutup Sabit Tip	NA1-2000-063003POF	80	252-630	3.848.00
NA1-2000 800 A 3 Kutup Sabit Tip	NA1-2000-080003POF	80	320-800	4.026.00
NA1-2000 1000 A 3 Kutup Sabit Tip	NA1-2000-100003POF	80	400-1000	4.161.00
NA1-2000 1250 A 3 Kutup Sabit Tip	NA1-2000-125003POF	80	500-1250	4.329.00
NA1-2000 1600 A 3 Kutup Sabit Tip	NA1-2000-160003POF	80	640-1600	4.375.00
NA1-2000 2000 A 3 Kutup Sabit Tip	NA1-2000-200003POF	80	800-2000	5.450.00
NA1-3200 2500 A 3 Kutup Sabit Tip	NA1-3200-250003POF	80	1000-2500	6.137.00
NA1-3200 3200 A 3 Kutup Sabit Tip	NA1-3200-320003POF	80	1280-3200	7.655.00
NA1-4000 4000 A 3 Kutup Sabit Tip	NA1-4000-400003POF	80	1600-4000	11.917.00

Elektronik koruma Üniteli Çekmeceli Tip 3 Kutuplu				
NA1-2000 630 A 3 Kutup Çekmeceli Tip	NA1-2000-063003POD	80	252-630	4.972.00
NA1-2000 800 A 3 Kutup Çekmeceli Tip	NA1-2000-080003POD	80	320-800	5.047.00
NA1-2000 1000 A 3 Kutup Çekmeceli Tip	NA1-2000-100003POD	80	400-1000	5.065.00
NA1-2000 1250 A 3 Kutup Çekmeceli Tip	NA1-2000-125003POD	80	500-1250	5.304.00
NA1-2000 1600 A 3 Kutup Çekmeceli Tip	NA1-2000-160003POD	80	640-1600	5.994.00
NA1-2000 2000 A 3 Kutup Çekmeceli Tip	NA1-2000-200003POD	80	800-2000	6.891.00
NA1-3200 2500 A 3 Kutup Çekmeceli Tip	NA1-3200-250003POD	80	1000-2500	8.459.00
NA1-3200 3200 A 3 Kutup Çekmeceli Tip	NA1-3200-320003POD	80	1280-3200	9.265.00
NA1-4000 4000 A 3 Kutup Çekmeceli Tip	NA1-4000-400003POD	80	1600-4000	15.732.00
NA1-6300 5000 A 3 Kutup Çekmeceli Tip	NA1-6300-500003POD	120	2000-5000	19.048.00

Aksesuarlar	Tipi	Fiyat (TL)
Motor 630-2000 A için	NA1-146	220 V AC 472.00
Motor 2500-5000 A için	NA1-147	220 V AC 557.00
Açtırma Bobini	NA1-148	220 V AC 140.00
Kapatma Bobini	NA1-148	220 V AC 140.00
Ani Düşük Gerilim Bobini	NA1-149	220 V AC 153.00
Asma Kilit	NA1-150	Bir Kilit ile Bir Anahtar 364.00
Asma Kilit	NA1-151	Üç Kilit ile iki Anahtar 984.00
Mekanik Kilit	NA1-152	Çubuk 660.00
Mekanik Kilit	NA1-153	Kablo 660.00
Geçikmeli Düşük gerilim Bobini	NA1-154	1-7 Saniye 254.00

Kompanzasyon için ideal ürün !

Yatay | AC Sınıfı

Sigortalı Ayırıcılar

CHNT

NHR17 Serisi Yük Ayırıcıları



690V'a kadar
AC 20/21/22 sınıfı

Ürün Tanımı	Sipariş Kodu	Uygun Sigorta	Fiyat (TL)
Mikro Siviçli 400 V 50Hz			
NHR17 Serisi 3 Kutup 160 A	NHR17-160/31	20,25,32,40,50,63,80,100,125,160	105.04
NHR17 Serisi 3 Kutup 250 A	NHR17-250/31	80,100,125,160,200,250	232.56
NHR17 Serisi 3 Kutup 400 A	NHR17-400/31	125,160,200,250,300,315,355,400	316.63
NHR17 Serisi 3 Kutup 630 A	NHR17-630/31	315,355,400,425,500,600	416.02

NHR17 Serisi Yatay Yük Ayırıcıları (Yeni Seri)

Ürün Tanımı	Sipariş Kodu	Uygun Sigorta	Fiyat (TL)	YENİ
Mikro Siviçli 400 V 50Hz				
NHR17 Serisi 3 Kutup 160 A	NHR17-160/31E	Boy 000 sigorta 90mm Genişlik	87.28	YENİ
NHR17 Serisi 3 Kutup 160 A	NHR17-160/31L	Boy 00 Sigorta 106mm Genişlik	87.28	YENİ
NHR17 Serisi 3 Kutup 250 A	NHR17-250/31E	80,100,125,160,200,250	222.56	
NHR17 Serisi 3 Kutup 400 A	NHR17-400/31E	125,160,200,250,300,315,355,400	306.60	
NHR17 Serisi 3 Kutup 630 A	NHR17-630/31E	315,355,400,425,500,600	406.02	



Sigortalı DC kesme için ideal

Yatay | AC / DC Sınıfı

Sigortalı Ayırıcılar

CHNT

NHR40 Serisi Yük Ayırıcıları

IEC IEC/EN60947-3



690VAC veya 440VDC uygulanabilir
AC 21/22 DC 21/22 sınıfı
Kollu

Ürün Tanımı 400 V	Sipariş Kodu	Uygun Sigorta AC21/ AC22/DC21/DC22	Fiyat (TL)
NHR40 Serisi 3 Kutup 160 A	NHR40-160/3	160	351.86
NHR40 Serisi 3 Kutup 250 A	NHR40-250/3	250	547.20
NHR40 Serisi 3 Kutup 400 A	NHR40-400/3	400	699.66
NHR40 Serisi 3 Kutup 630 A	NHR40-630/3	630	1261.40



Dar alanda ayırmak için dikey tip

Dikey | AC Sınıfı

Sigortalı Ayırıcılar

CHNT

NHRT40 Serisi Yük Ayırıcıları

IEC IEC/EN60947-3



690V'a kadar
AC 20/21/22 sınıfı

Ürün Tanımı 400 V	Sipariş Kodu	Uygun Sigorta AC21/ AC22/DC21/DC22	Fiyat (TL)
NHRT40 Serisi 3 Kutup 160 A	NHRT40-160/3	160	241.60
NHRT40 Serisi 3 Kutup 250 A	NHRT40-250/3	250	354.52
NHRT40 Serisi 3 Kutup 400 A	NHRT40-400/3	400	374.14
NHRT40 Serisi 3 Kutup 630 A	NHRT40-630/3	630	430.83



Dar alanda ayırmak için dikey tip

Dikey | AC Sınıfı

Sigortalı Ayırıcılar

CHNT

NHRT40 Serisi Dikey Yük Ayırıcıları (Yeni Seri)

IEC IEC/EN60947-3



Ürün Tanımı 400 V	Sipariş Kodu	Uygun Sigorta AC21/ AC22/DC21/DC22	Fiyat (TL)	YENİ
NHRT40 Serisi 3 Kutup 160 A	NHRT40-160/3E	100mm 3 Faz Açtırmalı (4-70mm ²)	147.63	YENİ
NHRT40 Serisi 3 Kutup 160 A	NHRT40-160/3L	185mm 1 Faz Ayrı Açtırmalı (4-70mm ²)	242.14	YENİ
NHRT40 Serisi 3 Kutup 250 A	NHRT40-250/3E	3 Faz Açtırmalı, M10	344.52	YENİ
NHRT40 Serisi 3 Kutup 250 A	NHRT40-250/3L	1 Faz Ayrı Açtırmalı, M10	344.52	YENİ
NHRT40 Serisi 3 Kutup 400 A	NHRT40-400/3E	3 Faz Açtırmalı, M10	364.14	YENİ
NHRT40 Serisi 3 Kutup 400 A	NHRT40-400/3L	1 Faz Ayrı Açtırmalı, M10	364.14	YENİ
NHRT40 Serisi 3 Kutup 630 A	NHRT40-630/3E	3 Faz Açtırmalı, M12	420.83	YENİ
NHRT40 Serisi 3 Kutup 630 A	NHRT40-630/3L	1 Faz Ayrı Açtırmalı, M12	420.83	YENİ



690VAC veya 440VDC uygulanabilir
AC 21/22 DC 21/22 sınıfı
Kollu



NH40 Serisi Yük Ayırıcıları

IEC IEC/EN60947-3

Ürün Tanımı 400 V	Fiyat (TL)
NH40 Serisi 125A 3 Kutup	142.40
NH40 Serisi 250A 3 Kutup	224.40
NH40 Serisi 400A 3 Kutup	341.70
NH40 Serisi 630A 3 Kutup	448.20
NH40 Serisi 1000 A 3 Kutup	484.96
NH40 Serisi 1250A 3 Kutup	878.24
NH40 Serisi 1600 A 3 Kutup	933.66
NH40 Serisi 2000 A 3 Kutup	2.692.80
NH40 Serisi 2500 A 3 Kutup	2.714.40
NH40 Serisi 3150 A 3 Kutup	3.151.80
NH40 Serisi için Yardımcı Kontak 1NA +1 NK	11.00
NH40 Serisi Metal Çubuk + Pano üstü Kol 630 a kadar	127.00
NH40 Serisi Metal Çubuk + Pano üstü Kol 1000-3150 a kadar	168.00



Tek boy
3/4 Kutup
690V'a Kadar



NC6 Serisi Mini Kontaktörler

IEC IEC/EN60947-4-1

Sipariş Kodu	Anma Gücü P(kW), 400 V AC	Anma Akımı I (A), AC3	Termik Akım Ith (A) AC1	Yardımcı Kontak	Fiyat (TL)	Minumum Sipariş
3 Kutuplu 220 V AC						
NC6-0610M	2.2	6	20	1NA	18.59	10
NC6-0601M	2.2	6	20	1NK	18.59	10
NC6-0910M	4	9	20	1NA	19.89	10
NC6-0901M	4	9	20	1NK	19.89	10
Yardımcı Kontak Bloğu						
NCF6-20			10	2NA	9.03	10
NCF6-02			10	2NK	9.03	10
NCF6-11			10	1NA+1NK	9.03	10
NCF6-40			10	4NA	11.53	10
NCF6-04			10	4NK	11.53	10
NCF6-22			10	2NA+2NK	11.53	10
NCF6-13			10	1NA+3 NK	11.53	10
NCF6-31			10	3NA+1 NK	11.53	10
Mini Termik						
NR2-11.5/0.16			0.1-0.16 A	1NA+1NK	26.44	10
NR2-11.5/0.25			0.16-0.25A	1NA+1NK	26.44	10
NR2-11.5/0.4			0.25-0.4 A	1NA+1NK	26.44	10
NR2-11.5/0.63			0.4-0.63A	1NA+1NK	26.44	10
NR2-11.5/1			0.63-1 A	1NA+1NK	26.44	10
NR2-11.5/2			1.25-2 A	1NA+1NK	26.44	10
NR2-11.5/4			2.5-4 A	1NA+1NK	25.68	10
NR2-11.5/6			4- 6 A	1NA+1NK	25.68	10
NR2-11.5/10			7-10 A	1NA+1NK	25.68	10
NR2-11.5/13			9-13 A	1NA+1NK	25.68	10
DIN raya Montaj Bloğu Uyumlu Termik (2 li Kutu)						
NAD-11.5			NR2-11.5		18.22	1

NC8 Serisi 24 V DC Bobinli Mini Kontaktör

Sipariş Kodu	Anma Gücü P(kW), 400 V AC	Anma Akımı I (A), AC3	Termik Akım Ith (A) AC1	Yardımcı Kontak	Fiyat (TL)	Min. Sipariş
3 Kutuplu 24 V DC						
NC8-0610BD	2.2	6	20	1NA	47.50	10
NC8-0601BD	2.2	6	20	1NK	47.50	10
NC8-0910BD	4	9	20	1NA	47.50	10
NC8-0901BD	4	9	20	1NK	47.50	10

NC1 Serisi Kontaktörler

IEC IEC/EN60947-4-1



3/4 Kutup
AC/DC bobinler
690V'a kadar

Sipariş Kodu	Anma Gücü P(kW), 400 V AC	Anma Akımı I (A), AC3	Termik Akım Ith (A) AC1	Yardımcı Kontakt	Fiyat (TL)	Min. Sipariş
3 Kutuplu 220 V AC						
NC1-0910M	4	9	20	1NA	22.50	10
NC1-0901M	4	9	20	1NK	22.50	10
NC1-1210M	5.5	12	20	1NA	25.09	10
NC1-1201M	5.5	12	20	1NK	25.09	10
NC1-1810M	7.5	18	32	1NA	32.63	10
NC1-1801M	7.5	18	32	1NK	32.63	10
NC1-2510M	11	25	40	1NA	39.71	5
NC1-2501M	11	25	40	1NK	39.71	5
NC1-3210M	15	32	50	1NA	58.28	5
NC1-3201M	15	32	50	1NK	58.28	5
NC1-4011M	18.5	40	60	1NA+1NK	88.81	5
NC1-5011M	22	50	80	1NA+1NK	123.85	5
NC1-6511M	30	65	80	1NA+1NK	146.13	5
NC1-8011M	37	80	95	1NA+1NK	181.61	4
NC1-9511M	45	95	95	1NA+1NK	233.27	4
4 Kutuplu 220 V AC						
NC1-0904M	4	9	20		42.46	10
NC1-1204M	5.5	12	20		52.83	10
NC1-2504M	11	25	40		73.23	5
NC1-4004M	18.5	40	60		162.94	5
NC1-5004M	22	50	80		235.19	5
NC1-6504M	30	65	80		278.88	5
NC1-8004M	37	80	95		309.22	4
NC1-9504M	45	95	95		332.64	4
3 Kutuplu 24 V DC						
NC1-0910BD	4	9	20	1NA	43.82	10
NC1-0901BD	4	9	20	1NK	43.82	10
NC1-1210BD	5.5	12	20	1NA	47.18	10
NC1-1201BD	5.5	12	20	1NK	47.18	10
NC1-1810BD	7.5	18	32	1NA	58.75	10
NC1-1801BD	7.5	18	32	1NK	58.75	10
NC1-2510BD	11	25	40	1NA	69.89	5
NC1-2501BD	11	25	40	1NK	69.89	5
NC1-3210BD	15	32	50	1NA	87.88	5
NC1-3201BD	15	32	50	1NK	87.88	5
NC1-4011BD	18.5	40	60	1NA+1NK	155.99	5
NC1-5011BD	22	50	80	1NA+1NK	182.76	5
NC1-6511BD	30	65	80	1NA+1NK	208.87	5
NC1-8011BD	37	80	95	1NA+1NK	235.98	4
NC1-9511BD	45	95	95	1NA+1NK	274.12	4
4 Kutuplu 220 VAC Bobinli (2NA+2NK ana Kontaktı)						
NC1-0908M	4	9	20		44.28	10





NC1 Serisi Kontaktör Aksesuarları

IEC IEC/EN60947-4-1

3/4 Kutup
AC/DC bobinler
690V'a kadar



Sipariş Kodu	Termik Akım Ith (A) AC1	Yardımcı Kontakt	Fiyat (TL)	Minimum Sipariş
Yardımcı Kontakt Bloğu				
NCF4-20	10	2NA	9.56	10
NSF4-02	10	2NK	9.56	10
NCF4-11	10	1NA + 1NK	9.56	10
NCF4-40	10	4NA	12.21	10
NCF-04	10	4NK	12.21	10
NCF4-22	10	2NA+2 NK	12.21	10
NCF4-13	10	1NA + 3NK	12.21	10
NCF4-31	10	3NA + 1NK	12.21	10

Zaman Rölesi	Ayar Sahası	Geçikme	Fiyat	Minimum Sipariş
NCF5-T0	0,1s-3s	Çekme	56.30	10
NCF5-T2	0,1s-30s	Çekme	56.30	10
NCF5-T4	10s-180s	Çekme	56.30	10
NCF5-D0	0,1s-3s	Düşme	56.30	10
NCF5-D2	0,1s-30s	Düşme	56.30	10
NCF5-D4	10s-180s	Düşme	56.30	10

Termikler	Uyumlu Kontaktörler	Termik Ayar Sahası	Yardımcı Kontakt	Fiyat	Minimum Sipariş
NR2-25/0.16	NC1-09...32	0,1-0,16 A	1NA + 1NK	34.43	10
NR2-25/0.25	NC1-09...32	0,16-0,25 A	1NA + 1NK	34.43	10
NR2-25/0.4	NC1-09...32	0,25-0,40 A	1NA + 1NK	34.43	10
NR2-25/0.63	NC1-09...32	0.40-0,63 A	1NA + 1NK	34.43	10
NR2-25/1	NC1-09...32	0,63-1 A	1NA + 1NK	34.43	10
NR2-25/1.6	NC1-09...32	1-1.6 A	1NA + 1NK	34.43	10
NR2-25/2	NC1-09...32	1,25-2 A	1NA + 1NK	34.43	10
NR2-25/2.5	NC1-09...32	1.6-2,5 A	1NA + 1NK	34.43	10
NR2-25/4	NC1-09...32	2,5-4 A	1NA + 1NK	34.43	10
NR2-25/6	NC1-09...32	4-6 A	1NA + 1NK	34.43	10
NR2-25/8	NC1-09...32	5,5-8A	1NA + 1NK	34.43	10
NR2-25/10	NC1-09...32	7- 10 A	1NA + 1NK	34.43	10
NR2-25/13	NC1-09...32	9-13 A	1NA + 1NK	34.43	10
NR2-25/18	NC1-09...32	12-18 A	1NA + 1NK	34.43	10
NR2-25/25	NC1-09...32	17 -25 A	1NA + 1NK	34.43	10
NR2-36/32	NC1-32	23 - 32 A	1NA + 1NK	36.00	10
NR2-36/36	NC1-32	28 - 36 A	1NA + 1NK	36.00	10
NR2-93/32	NC1-40...95	23 - 32 A	1NA + 1NK	50.44	10
NR2-93/40	NC1-40...95	30 -40 A	1NA + 1NK	50.44	10
NR2-93/50	NC1-40...95	37 -50 A	1NA + 1NK	61.88	10
NR2-93/65	NC1-40...95	48-65 A	1NA + 1NK	61.88	10
NR2-93/70	NC1-40...95	55 -70 A	1NA + 1NK	61.88	10
NR2-93/80	NC1-40...95	63 - 80 A	1NA + 1NK	61.88	10
NR2-93/93	NC1-40...95	80 -93 A	1NA + 1NK	144.00	10
NR2-200/125	NC2-115	80-125 A	1NA + 1NK	194.38	10
NR2-200/160	NC2-185	100- 160 A	1NA + 1NK	202.04	10
NR2-200/200	NC2-225	125- 200 A	1NA + 1NK	297.00	10

Mekanik Kilit	Uyumlu Kontaktörler	Fiyat
NC1-H01	09/12/18/25/32 A	16.31
NC1-H02	40/50/65 A	19.58
NC1-H03	90/95 A	39.38

Din Raya Montaj Bloğu	Uyumlu Termik	Fiyat
NAD-25	NR2-25	20.60 1
NAD-36	NR2-36	44.14 1
NAD-93	NR2-95	84.82 1

Bobin	Uyumlu Kontaktörler	Besleme Gerilimi	Fiyat
NC1-C01B	09/12/18 A	220 V AC 50/60 Hz	16.26
NC1-C02B	25/32 A	220 V AC 50/60 Hz	27.30
NC1-C03B	40/50/65/80/95 A	220 V AC 50/60 Hz	34.13

NC2 Serisi Kontaktörler



Sipariş Kodu	Anma Gücü P(kW), 400 V AC	Anma Akımı I (A), AC3	Termik Akım Ith (A) AC1	Yardımcı Kontakt	Fiyat (TL)
3 Kutuplu 220 V AC					
NC2-115M	55	115	200		288.23
NC2-150M	75	150	200		412.77
NC2-185M	90	185	275		521.84
NC2-225M	110	225	275		722.68
NC2-265M	132	265	315		788.38
NC2-330M	160	330	380		894.82
NC2-400M	200	400	450		1.099.00
NC2-500M	250	500	630		1.732.00
NC2-630M	335	600	800		2.347.00



4 Kutuplu 220 V AC						
NC2-115M4	55	115	200	-	573.00	YENİ
NC2-150M4	75	150	200	-	695.00	YENİ
NC2-185M4	90	185	275	-	762.00	YENİ
NC2-225M4	110	225	275	-	799.00	YENİ
NC2-265M4	132	265	315	-	855.00	YENİ
NC2-330M4	160	330	380	-	1.236.00	YENİ
NC2-400M4	200	400	450	-	1.325.00	YENİ
NC2-630M4	335	600	800	-	2.542.00	YENİ



Yardımcı Kontakt Bloğu					
NCF4-20			10	2NA	9.56
NCF4-02			10	2NK	9.56
NCF4-11			10	1NA+1NK	9.56
NCF4-40			10	4NA	12.21
NCF4-04			10	4NK	12.21
NCF4-22			10	2NA +2NK	12.21
NCF4-13			10	1NA + 3 NK	12.21
NCF4-31			10	3NA +1 NK	12.21



Zaman Rölesi					
NCF5-T0				1NA + 1NK	56.30
NCF5-T2				1NA + 1NK	56.30
NCF5-T4				1NA + 1NK	56.30
NCF5-D0				1NA + 1NK	56.30
NCF5-D2				1NA + 1NK	56.30
NCF5-D4				1NA + 1NK	56.30



Termikler (Isı Kompanzasyonlu)					
NR2-200/125				1NA + 1NK	194.38
NR2-200/160				1NA + 1NK	202.04
NR2-200/200				1NA + 1NK	297.00
NR2-630/250				1NA + 1NK	312.42
NR2-630/315				1NA + 1NK	355.50
NR2-630/400				1NA + 1NK	369.50
NR2-630/500				1NA + 1NK	533.59
NR2-630/630				1NA + 1NK	587.72



Yatay Mekanik Kilit					
NC2-H01					39.38
NC2-H02					59.29
NC2-H03					67.28
NC2-H04					118.00

Sipariş Kodu	Fiyat (TL)
Bobinler (3 KUTUPLU)	
NC2-C01 (220 V AC 115/150)	79.11
NC2-C02 (220 V AC 185/225)	84.23
NC2-C03 (220 V AC 265)	139.23
NC2-C04 (220 V AC 330)	159.78
NC2-C05 (220 V AC 400)	165.28
NC2-C06 (220 V AC 500)	177.62
NC2-C07 (220 V AC 630)	215.25

Sipariş Kodu	Fiyat (TL)
Bobinler (4 KUTUPLU)	
NC2-C014 (220 V AC 115/150)	81.58
NC2-C024 (220 V AC 185/225)	88.25
NC2-C034 (220 V AC 265)	145.95
NC2-C044 (220 V AC 330)	166.95
NC2-C054 (220 V AC 400)	173.38
NC2-C064 (220 V AC 500)	189.39
NC2-C074 (220 V AC 630)	299.57



NS2 Serisi Motor Koruma Şalterleri

IEC/EN60947-4

Sağlam yapı
Yüksek kesme kapasitesi
Zengin aksesuar



Sipariş Kodu	Anma Gücü P(kW), 400 V AC	Kesme Kap. Icu (kA), 400 V AC	Termik Akım Ith (A) AC1	Yardımcı Kontakt	Fiyat (TL)
3 Kutuplu 220 V AC					
NS2-25-0.16	-	100	0.1-0.16 A		50.63
NS2-25-0.25	-	100	0.16-0.25 A		50.63
NS2-25-0.4	-	100	0.25 - 0.4 A		50.63
NS2-25-0.63	-	100	0.4 -0.63 A		50.63
NS2-25-1	--	100	0.63-1 A		50.63
NS2-25-1.6	0.37	100	1- 1.6 A		50.63
NS2-25-2.5	0.75	100	1.6 -2,5 A		50.63
NS2-25-4	1.5	100	2,5 -4 A		50.63
NS2-25-6.3	2.2	100	4- 6,3 A		50.63
NS2-25-10	4.0	100	6- 10 A		54.00
NS2-25-14	5.5	15	9-14 A		54.00
NS2-25-18	7.5	15	13 -18 A		54.00
NS2-25-23	11.0	15	17-23 A		69.75
NS2-25-25	11.0	15	20 -25 A		69.75
NS2-80B/40	18.5	25	25-40A		219.00 YENİ
NS2-80B/63	30	25	40-63 A		229.00 YENİ
NS2-80B/80	37	25	63-80 A		305.00 YENİ

NM8 Serisi Motor Koruma Şalterleri

Motor Parametreleri		Motor Koruma Şalteri		Kontaktör Parametreleri		Termik Röle Parametreleri		Fiyat (TL)
Güç kW	Akım A	Sipariş Kodu	Manyetik Akım	Ürün	AC3 Akım(A)	Ürün	Ith Akım(A)	
15	28	123015	384 A	NC1-40	60 A	NR2-36	23-32	249.00
18.5	34,1	123016	480 A	NC1-50	80 A	NR2-26	28-36	249.00
22	39,4	123017	600 A	NC1-65	80 A	NR2-93	30-40	249.00
30	53,4	123018	756 A	NC1-80	110 A	NR2-93	48-65	439.00
37	67,9	123019	960 A	NC1-95	110 A	NR2-93	55-70	439.00
45	80,5	123020	1200 A	NC2-115	200 A	NR2-93	80-93	439.00
55	98,5	123020	1500 A	NC2-150	200 A	NR2-200	80-125	479.00
75	133	123054	1920 A	NC2-185	275 A	NR2-200	100-160	479.00
90	158,7	123055	2400 A	NC2-225	275 A	NR2-200	100-160	630.00
110	192	123056	3000 A	NC2-265	315 A	NR2-200	125-200	725.00

Not: Fiyata Sadece Motor koruma şalteri dahildir diğer veriler bilgi amaçlı sunulmuştur.

Düşük Gerilim Açırma	Çalışma Sahası	Gerilim	
NS2-UV380	-	%35-%70	380V
			27.56
Uzaktan Açırma	Çalışma Sahası	Gerilim	
NS2-SH380	-	%70-%110	380V
			27.56
Yardımcı Kontakt üstüne Montaj	Kontakt	Çalışma Akımı	
NS2-AE20	-	2NA	2,5A
NS2-AE11		1NA +1 NK	2,5A
			9.00
Yardımcı Kontakt sağ/sola Montaj	Kontakt	Çalışma Akımı	
NS2-AU20	-	2NA	6A
NS2-AU11		1NA +1 NK	6A
			10.13
Hata ve Ani Açırma Kontaklı-sola Montaj	Kontakt	Çalışma Akımı	
NS2-FA0110	-	1NA +1 NK	6A
NS2-FA1010		1NA +1 NK	6A
			14.06
			14.06
IP Sınıfı Yüksek Kutular			
NS2-MC01		Suya Karşı Koruma Sınıfı Yüksek Stop Butonlu Kutu	44.00
NS2-MC		Suya Karşı Koruması Yüksek	32.00

JQX Endüstriyel Röleler Role ve Soketleri



Ürün Tanımı	Sipariş Kodu	Besleme gerilimi	Fiyat (TL)	
JQX serisi 10 A, 2 Kontak, 8 Bacaklı Test Butonlu	JQX-10F 2Z AC24V	24 V AC	11.63	YENİ
JQX serisi 10 A, 2 Kontak, 8 Bacaklı Test Butonlu	JQX-10F 2Z AC36V	36 V AC	11.95	YENİ
JQX serisi 10 A, 2 Kontak, 8 Bacaklı Test Butonlu	JQX-10F 2Z AC48V	48 V AC	12.38	YENİ
JQX serisi 10 A, 2 Kontak, 8 Bacaklı Test Butonlu	JQX-10F 2Z AC110V	110 V AC	11.52	YENİ
JQX serisi 10 A, 2 Kontak, 8 Bacaklı Test Butonlu	JQX-10F 2Z AC127V	127 V AC	12.22	YENİ
JQX serisi 10 A, 2 Kontak, 8 Bacaklı Test Butonlu	JQX-10F 2Z AC220V	220 V AC	12.25	YENİ
JQX serisi 10 A, 2 Kontak, 8 Bacaklı Test Butonlu	JQX-10F 2Z AC380V	380 V AC	13.99	YENİ
JQX serisi 10 A, 2 Kontak, 8 Bacaklı Test Butonlu	JQX-10F 2Z DC24V	24 V DC	11.83	YENİ
JQX serisi 10 A, 2 Kontak, 8 Bacaklı Test Butonlu	JQX-10F 2Z DC36V	36 V DC	11.64	YENİ
JQX serisi 10 A, 2 Kontak, 8 Bacaklı Test Butonlu	JQX-10F 2Z DC48V	48 V DC	11.64	YENİ
JQX serisi 10 A, 2 Kontak, 8 Bacaklı Test Butonlu	JQX-10F 2Z DC110V	110 V DC	12.51	YENİ
JQX serisi 10 A, 2 Kontak, 8 Bacaklı Test Butonlu	JQX-10F 2Z DC127V	127 V DC	12.51	YENİ
JQX serisi 10 A, 2 Kontak, 8 Bacaklı Test Butonlu	JQX-10F 2Z DC220V	220 V DC	13.66	YENİ
JQX serisi 10 A, 3 Kontak, 11 Bacaklı Test Butonlu	JQX-10F 3Z AC24V	24 V AC	13.48	YENİ
JQX serisi 10 A, 3 Kontak, 11 Bacaklı Test Butonlu	JQX-10F 3Z AC36V	36 V AC	13.48	YENİ
JQX serisi 10 A, 3 Kontak, 11 Bacaklı Test Butonlu	JQX-10F 3Z AC48V	48 V AC	13.48	YENİ
JQX serisi 10 A, 3 Kontak, 11 Bacaklı Test Butonlu	JQX-10F 3Z AC110V	110 V AC	13.80	YENİ
JQX serisi 10 A, 3 Kontak, 11 Bacaklı Test Butonlu	JQX-10F 3Z AC127V	127 V AC	13.91	YENİ
JQX serisi 10 A, 3 Kontak, 11 Bacaklı Test Butonlu	JQX-10F 3Z AC220V	220 V AC	13.99	YENİ
JQX serisi 10 A, 3 Kontak, 11 Bacaklı Test Butonlu	JQX-10F 3Z AC380V	380 V AC	15.42	YENİ
JQX serisi 10 A, 3 Kontak, 11 Bacaklı Test Butonlu	JQX-10F 3Z DC18V	18 V DC	13.55	YENİ
JQX serisi 10 A, 3 Kontak, 11 Bacaklı Test Butonlu	JQX-10F 3Z DC24V	24 V DC	13.55	YENİ
JQX serisi 10 A, 3 Kontak, 11 Bacaklı Test Butonlu	JQX-10F 3Z DC36V	36 V DC	13.37	YENİ
JQX serisi 10 A, 3 Kontak, 11 Bacaklı Test Butonlu	JQX-10F 3Z DC48V	48 V DC	13.37	YENİ
JQX serisi 10 A, 3 Kontak, 11 Bacaklı Test Butonlu	JQX-10F 3Z DC110V	110 V DC	14.12	YENİ
JQX serisi 10 A, 3 Kontak, 11 Bacaklı Test Butonlu	JQX-10F 3Z DC127V	127 V DC	14.12	YENİ
JQX serisi 10 A, 3 Kontak, 11 Bacaklı Test Butonlu	JQX-10F 3Z DC220V	220 V DC	14.88	YENİ



JQX Serisine Uygun Soketler

Ürün Tanımı	Sipariş Kodu	Fiyat	
JQX-10F 2Z için 8 Pinli Soket	CZF08A	2.89	YENİ
JQX-10F 2Z için 8 Pinli Soket Parmak Korumalı	CZF08A-E	3.49	YENİ
JQX-10F 3Z için 11 Pinli Soket	CZF11A	3.49	YENİ
JQX-10F 3Z için 11 Pinli Soket Parmak Korumalı	CZF11A-E	3.79	YENİ



NQ3 Serisi Kutulu Yolvericiler

IEC/EN60947-1

Plastik Gövde
Yüksek Sızdırmazlık
Start/Stop Butonu
380 VAC bobinli



Sipariş Kodu	Anma Gücü P(kW), 400 V AC	Dahili Kontaktör +Termik	Ayar Sahası	Fiyat (TL)
400 VAC 50/60 Hz (Kontrol Gerilimi 380 V AC)				
NQ3-5.5P 380 V / 1.6A	-	NC1-1810+NR-25	1-1,6	80.39
NQ3-5.5P 380 V / 2.5A	-	NC1-1810+NR-25	1,6-2,5	80.39
NQ3-5.5P 380 V / 4A	-	NC1-1810+NR-25	2,5-4	80.39
NQ3-5.5P 380 V / 6A	5.5	NC1-1810+NR-25	4-6,0	93.38
NQ3-5.5P 380 V / 8A	5.5	NC1-1810+NR-25	5,5-8	93.38
NQ3-5.5P 380 V / 10A	5.5	NC1-1810+NR-25	7-10,0	93.38
NQ3-5.5P 380 V / 13A	5.5	NC1-1810+NR-25	9-13,0	93.38
NQ3-11 P 380 V / 18A	11	NC1-3210+NR-25	12-18,0	106.85
NQ3-11 P 380 V / 25 A	11	NC1-3210+NR-25	17-25	106.85
400 VAC 50/60 Hz (Kontrol Gerilimi 220 V AC)				
NQ3-5.5P 220 V / 1.6A	-	NC1-1810+NR-25	1-1,6	80.39
NQ3-5.5P 220 V / 2.5A	-	NC1-1810+NR-25	1,6-2,5	80.39
NQ3-5.5P 220 V / 4A	-	NC1-1810+NR-25	2,5-4	80.39
NQ3-5.5P 220 V / 6A	5.5	NC1-1810+NR-25	4-6,0	93.38
NQ3-5.5P 220 V / 8A	5.5	NC1-1810+NR-25	5,5-8	93.38
NQ3-5.5P 220 V / 10A	5.5	NC1-1810+NR-25	7-10,0	93.38
NQ3-5.5P 220 V / 13A	5.5	NC1-1810+NR-25	9-13,0	93.38
NQ3-11 P 220 V / 18A	11	NC1-3210+NR-25	12-18,0	106.85
NQ3-11 P 220 V / 25 A	11	NC1-3210+NR-25	17-25	106.85

Bağlantı Şeması

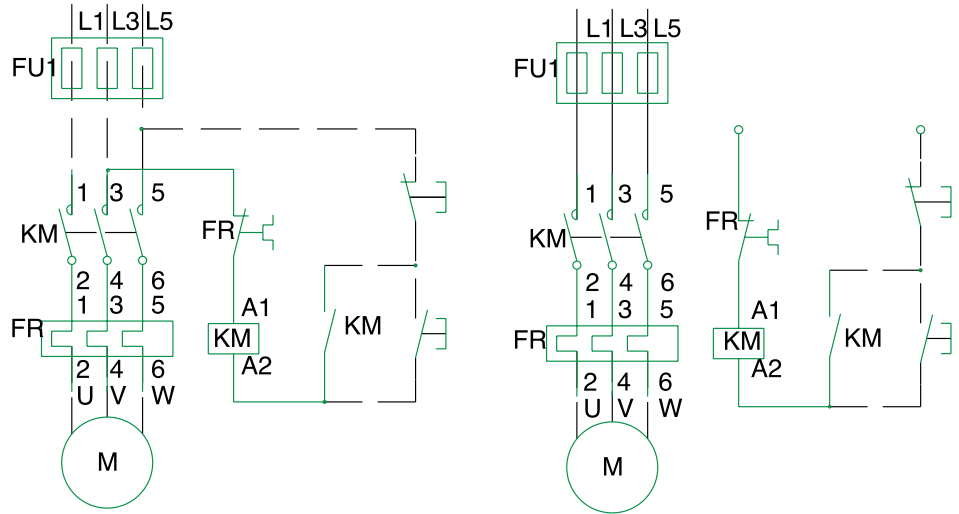

Kontrol beslemesi kaynaktan

Kontrol beslemesi dışardan

Boyutlar

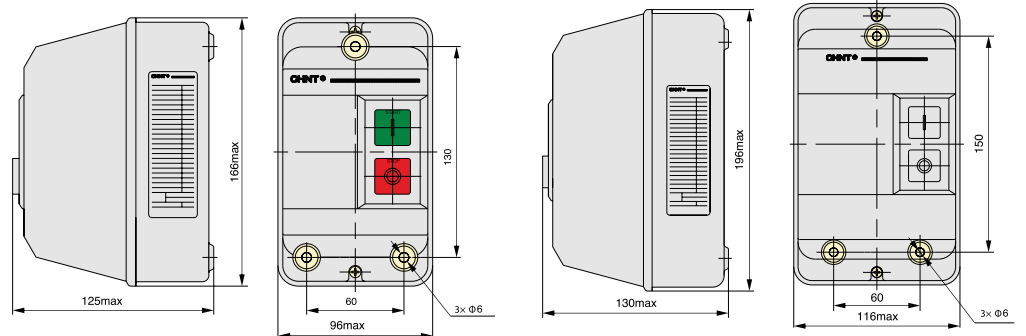

NQ3-5.5P

NQ3-11P

NP2 Serisi 22mm Metal Seri Buton ve Sinyal Lambası

IEC IEC/EN60947-5-1



Korunmalı köprü LED grubu
Parlak homojen ışık yüzeyi
Zengin aksesuar
Vida bağlantılı sağlam kontak yapısı
Eklenir ilave kontak



Ürün Tanımı 220/380 V AC	Kontak	Renk	Sipariş Kodu	Fiyat (TL)	Min. Sipariş
Yaylı Buton	1NA	Beyaz	NP2-BA11	6.02	10
Yaylı Buton	1NA	Siyah	NP2-BA21	6.02	10
Yaylı Buton	1NA	Yeşil	NP2-BA31	6.02	10
Yaylı Buton	1NA	Sarı	NP2-BA51	6.02	10
Yaylı Buton	1NA	Mavi	NP2-BA61	6.02	10
Yaylı Buton	1NK	Kırmızı	NP2-BA42	6.02	10
40mm Mantar Yaylı Buton	1NA	Siyah	NP2-BC21	11.37	10
60 mm Mantar Yaylı Buton	1NA	Siyah	NP2-BR21	13.77	
Acil Stop Butonu 40 mm	1NK	Kırmızı	NP2-BS542	11.63	10
Acil Stop Butonu 60 mm	1NK	Kırmızı	NP2-BS642	13.77	10
İkiz Buton, Start/Stop	1NA+1NK	Yeşil + Kırmızı	NP2-BL8425	12.85	10
İkiz Buton Start/Stop/Işıklı LED'li 24 V	1NA+1NK	Yeşil +Kırmızı	NP2-BW8465LB	20.04	10
İkiz Buton Start/Stop/Işıklı LED'li 220V	1NA+1NK	Yeşil + Kırmızı	NP2-BW8465LM	20.04	10
Işıklı yaylı Buton, LED'li 24 VAC / DC	1NA + 1NK	Beyaz	NP2-BW3165LB	20.80	10
Işıklı yaylı Buton, LED'li 24 VAC / DC	1NA + 1NK	Yeşil	NP2-BW3365LB	20.80	10
Işıklı yaylı Buton, LED'li 24 VAC / DC	1NA + 1NK	Kırmızı	NP2-BW3465LB	20.80	10
Işıklı yaylı Buton, LED'li 24 VAC / DC	1NA + 1NK	Sarı	NP2-BW3565LB	20.80	10
Işıklı yaylı Buton, LED'li 24 VAC / DC	1NA + 1NK	Mavi	NP2-BW3665LB	20.80	10
Işıklı Yaylı Buton , LED'li 220 V AC/DC	1NA + 1NK	Beyaz	NP2-BW3165LM	18.72	10
Işıklı Yaylı Buton , LED'li 220 V AC/DC	1NA + 1NK	Yeşil	NP2-BW3365LM	18.72	10
Işıklı Yaylı Buton , LED'li 220 V AC/DC	1NA + 1NK	Kırmızı	NP2-BW3465LM	18.72	10
Işıklı Yaylı Buton , LED'li 220 V AC/DC	1NA + 1NK	Sarı	NP2-BW3565LM	18.72	10
Işıklı Yaylı Buton , LED'li 220 V AC/DC	1NA + 1NK	Mavi	NP2-BW3665LM	18.72	10
Plastik Korunmalı, Yaylı Buton	1NA	Siyah	NP2-BP21	8.77	10
Plastik Korunmalı, Yaylı Buton	1NA	Yeşil	NP2-BP31	8.77	10
Plastik Korunmalı, Yaylı Buton	1NA	Sarı	NP2-BP51	8.77	10
Plastik Korunmalı, Yaylı Buton	1NK	Kırmızı	NP2-BP42	8.77	10
Mandal Buton, 2 Konum Kalıcı	1NA	Siyah	NP2-BD21	9.03	10
Mandal Buton, 3 Konum Kalıcı	1NA+1NK	Siyah	NP2-BD33	11.73	10
Mandal Buton, 3 Konum geriye Yaylı	1NA+1NK	Siyah	NP2-BD53	13.01	10
Uzun Mandal Buton, 2 Konum Kalıcı	1NA	Siyah	NP2-BJ21	9.84	10
Uzun Mandal Buton, 3 Konum Kalıcı	1NA+1NK	Siyah	NP2-BJ33	13.01	10
Uzun Mandal Buton, 3 Konum geriye Yaylı	1NA+1NK	Siyah	NP2-BJ53	13.77	10
Kilit Buton 2 Konumlu	1NA	Siyah	NP2-BG21	22.59	10
Kilit Buton 3 Konumlu, Kilit her Yönde.	1NA+1NK	Siyah	NP2-BG03	28.05	10
Kilit Buton 3 Konumlu, Kilit Ortada	1NA+1NK	Siyah	NP2-BG33	28.05	10
Sinyal lambası, LED'li 220 V AC/DC		Beyaz	NP2-BV61LM	9.33	10
Sinyal lambası, LED'li 220 V AC/DC		Yeşil	NP2-BV63LM	9.33	10
Sinyal lambası, LED'li 220 V AC/DC		Kırmızı	NP2-BV64LM	9.33	10
Sinyal lambası, LED'li 220 V AC/DC		Sarı	NP2-BV65LM	9.33	10
Sinyal lambası, LED'li 220 V AC/DC		Mavi	NP2-BV66LM	9.33	10
Sinyal Lambası, LED'li 24 V AC/DC		Beyaz	NP2-BV61LB	10.36	10
Sinyal Lambası, LED'li 24 V AC/DC		Yeşil	NP2-BV63LB	10.36	10
Sinyal Lambası, LED'li 24 V AC/DC		Kırmızı	NP2-BV64LB	10.36	10
Sinyal Lambası, LED'li 24 V AC/DC		Sarı	NP2-BV65LB	10.36	10
Sinyal Lambası, LED'li 24 V AC/DC		Mavi	NP2-BV66LB	10.36	10



NP2 Serisi 22mm Plastik Seri Buton ve Sinyal Lambası

IEC IEC/EN60947-4

Korumalı köprü LED grubu
Parlak homojen ışık yüzeyi
Zengin aksesuar
Vida bağlantılı sağlam kontak yapısı
Eklebilir ilave kontak

















Ürün Tanımı 220/380 V AC	Kontakt	Renk	Sipariş Kodu	Fiyat (TL)	Minumum Sipariş
Yaylı Buton	1NA	beyaz	NP2-EA11	3.65	10
Yaylı Buton	1NA	Siyah	NP2-EA21	3.65	10
Yaylı Buton	1NA	Yeşil	NP2-EA31	3.65	10
Yaylı Buton	1NA	Sarı	NP2-EA51	3.65	10
Yaylı Buton	1NA	Mavi	NP2-EA61	3.65	10
Yaylı Buton	1NK	Kırmızı	NP2-EA42	3.65	10
40mm Mantar Yaylı Buton	1NK	Siyah	NP2-EC21	7.63	10
Acil Stop Butonu 40 mm	1NK	Kırmızı	NP2-ES542	6.25	10
Acil Stop Butonu 60 mm	1NK	Kırmızı	NP2-ES642	8.25	10
İkiz Buton, Start/Stop	1NA+1NK	Yeşil + Kırmızı	NP2-EL8425	9.83	10
İkiz Buton Start/Stop/Işıklı LED'li 24 V	1NA+1NK	Yeşil +Kırmızı	NP2-EW8465LB	11.25	10
İkiz Buton Start/Stop/Işıklı LED'li 220V	1NA+1NK	Yeşil + Kırmızı	NP2-EW8465LM	11.25	10
Işıklı yaylı Buton, LED'li 24 VAC / DC	1NA + 1NK	Beyaz	NP2-EW3165LB	16.87	10
Işıklı yaylı Buton, LED'li 24 VAC / DC	1NA + 1NK	Yeşil	NP2-EW3365LB	16.87	10
Işıklı yaylı Buton, LED'li 24 VAC / DC	1NA + 1NK	Kırmızı	NP2-EW3465LB	16.87	10
Işıklı yaylı Buton, LED'li 24 VAC / DC	1NA + 1NK	Sarı	NP2-EW3565LB	16.87	10
Işıklı yaylı Buton, LED'li 24 VAC / DC	1NA + 1NK	Mavi	NP2-EW3665LB	16.87	10
Işıklı Yaylı Buton , LED'li 220 V AC/DC	1NA + 1NK	Beyaz	NP2-EW3165LM	15.20	10
Işıklı Yaylı Buton , LED'li 220 V AC/DC	1NA + 1NK	Yeşil	NP2-EW3365LM	15.20	10
Işıklı Yaylı Buton , LED'li 220 V AC/DC	1NA + 1NK	Kırmızı	NP2-EW3465LM	15.20	10
Işıklı Yaylı Buton , LED'li 220 V AC/DC	1NA + 1NK	Sarı	NP2-EW3565LM	15.20	10
Işıklı Yaylı Buton , LED'li 220 V AC/DC	1NA + 1NK	Mavi	NP2-EW3665LM	15.20	10
Mandal Buton, 2 Konum Kalıcı	1NA	Siyah	NP2-ED21	6.53	10
Mandal Buton, 3 Konum Kalıcı	1NA+1NK	Siyah	NP2-ED33	8.47	10
Mandal Buton, 3 Konum geriye Yaylı	1NA+1NK	Siyah	NP2-ED53	8.77	10
Uzun Mandal Buton, 2 Konum Kalıcı	1NA	Siyah	NP2-EJ21	7.29	10
Uzun Mandal Buton, 3 Konum Kalıcı	1NA+1NK	Siyah	NP2-EJ33	9.38	10
Uzun Mandal Buton, 3 Konum geriye Yaylı	1NA+1NK	Siyah	NP2-EJ53	10.12	10
Kilit Buton 2 Konumlu	1NA	Siyah	NP2-EG21	16.37	10
Kilit Buton 3 Konumlu, Kilit her Yönde.	1NA+1NK	Siyah	NP2-EG03	16.88	10
Kilit Buton 3 Konumlu, Kilit Ortada	1NA+1NK	Siyah	NP2-EG33	17.18	10
Sinyal lambası, LED'li 220 V AC/DC		Beyaz	NP2-EV61LM	6.99	10
Sinyal lambası, LED'li 220 V AC/DC		Yeşil	NP2-EV63LM	6.99	10
Sinyal lambası, LED'li 220 V AC/DC		Kırmızı	NP2-EV64LM	6.99	10
Sinyal lambası, LED'li 220 V AC/DC		Sarı	NP2-EV65LM	6.99	10
Sinyal lambası, LED'li 220 V AC/DC		Mavi	NP2-EV66LM	6.99	10
Sinyal Lambası, LED'li 24 V AC/DC		Beyaz	NP2-EV61LB	6.99	10
Sinyal Lambası, LED'li 24 V AC/DC		Yeşil	NP2-EV63LB	6.99	10
Sinyal Lambası, LED'li 24 V AC/DC		Kırmızı	NP2-EV64LB	6.99	10
Sinyal Lambası, LED'li 24 V AC/DC		Sarı	NP2-EV65LB	6.99	10
Sinyal Lambası, LED'li 24 V AC/DC		Mavi	NP2-EV66LB	6.99	10

NP2 Serisi Butonlar için Yardımcı Aksesuarlar

Ürün Tanımı 220/380 V AC	Kontakt	Renk	Sipariş Kodu	Fiyat (TL)	Minumum Sipariş
İlave Kontak	1NA		NP2-BE101	3.01	10
İlave Kontak	1NK		NP2-BE102	3.01	10
Pano Etiketi			NP2-BZ21	0.78	100
Sarı renk Dairesel Etiket(Acil Durdurma)			NP2-BY9330	1.87	100

NP2 Kutular



Ürün Kodu	Fiyat (TL)	Ürün Kodu	Fiyat (TL)
 NP2-B01	6.57 YENİ	 NP2-B211H29	19.28 YENİ
 NP2-B02	6.72 YENİ	 NP2-B222	23.28 YENİ
 NP2-B03	8.35 YENİ	 NP2-B223	23.28 YENİ
 NP2-J01	9.57 YENİ	 NP2-B311H29 (İleri, Dur, Geri)	35.29 YENİ
 NP2-B101H29	16.61 YENİ	 NP2-B324	36.29 YENİ
 NP2-J174	18.68 YENİ	 NP2-B339	36.29 YENİ
 NP2-J174H29	18.68 YENİ	 NP2-B366	36.29 YENİ



NP8 Serisi 22mm Metal Seri Buton ve Sinyal Lambası



Ürün Tanımı 220/380 V AC	Kontak	Renk	Sipariş Kodu	Fiyat (TL)	Min. Sipariş	
Yaylı Buton	1NA	Beyaz	NP8-10BN/1	8.83	10	YENİ
Yaylı Buton	1NA	Siyah	NP8-10BN/2	8.83	10	YENİ
Yaylı Buton	1NA	Yeşil	NP8-10BN/3	8.83	10	YENİ
Yaylı Buton	1NA	Sarı	NP8-10BN/5	8.83	10	YENİ
Yaylı Buton	1NA	Mavi	NP8-10BN/6	8.83	10	YENİ
Yaylı Buton	1NK	Kırmızı	NP8-10BN/4	8.83	10	YENİ
40mm Mantar Yaylı Buton	1NA	Siyah	NP8-10M/12	12.75	10	YENİ
Acil Stop Butonu 60 mm	1NK	Kırmızı	NP8-10M/24	21.15	10	YENİ
İkiz Buton, Start/Stop	1NA+1NK	Yeşil + Kırmızı	NP8-11S	17.25	10	YENİ
İkiz Buton Start/Stop/Işıklı LED'li 24 VAC /DC & 220 VAC	1NA+1NK	Yeşil + Kırmızı	NB8-11SD	28.75	10	YENİ
Işıklı Yaylı Buton , LED'li 24 VAC /DC & 220 VAC	1NA	Beyaz	NP8-10BND/1	17.75	10	YENİ
Işıklı Yaylı Buton , LED'li 24 VAC /DC & 220 VAC	1NA	Yeşil	NP8-10BND/3	17.75	10	YENİ
Işıklı Yaylı Buton , LED'li 24 VAC /DC & 220 VAC	1NA	Kırmızı	NP8-10BND/4	17.75	10	YENİ
Işıklı Yaylı Buton , LED'li 24 VAC /DC & 220 VAC	1NA	Sarı	NP8-10BND/5	17.75	10	YENİ
Işıklı Yaylı Buton , LED'li 24 VAC /DC & 220 VAC	1NA	Mavi	NP8-10BND/6	17.75	10	YENİ
Mandal Buton, 2 Konum Kalıcı	1NA	Siyah	NP8-10X/212	14.13	10	YENİ
Mandal Buton, 3 Konum Kalıcı	1NA+1NK	Siyah	NP8-11X/312	16.72	10	YENİ
Işıklı Mandal Buton, 2 Konum Kalıcı 24VAC/DC & 220VAC	1NA+1NK	Yeşil	NP8-10XD/213	25.28	10	YENİ
Işıklı Mandal Buton, 2 Konum Kalıcı 24VAC/DC & 220VAC	1NA+1NK	Kırmızı	NP8-10XD/214	25.28	10	YENİ
Işıklı Mandal Buton, 2 Konum Kalıcı 24VAC/DC & 220VAC	1NA+1NK	Sarı	NP8-10XD/215	25.28	10	YENİ
Işıklı Mandal Buton, 3 Konum Kalıcı 24VAC/DC & 220VAC	1NA+1NK	Yeşil	NP8-10XD/313	27.28	10	YENİ
Işıklı Mandal Buton, 3 Konum Kalıcı 24VAC/DC & 220VAC	1NA+1NK	Kırmızı	NP8-10XD/314	27.28	10	YENİ
Işıklı Mandal Buton, 3 Konum Kalıcı 24VAC/DC & 220VAC	1NA+1NK	Sarı	NP8-10XD/315	27.28	10	YENİ
Kilit Buton 2 Konumlu	1NA	Metalik	NP8-10Y/21	35.61	10	YENİ
Kilit Buton 3 Konumlu, Kilit her Yönde.	1NA+1NK	Metalik	NP8-11Y/31	37.28	10	YENİ
Sinyal Lambası , LED'li 24 VAC /DC & 220 VAC		Beyaz	NP8-D/1	21.75	10	YENİ
Sinyal Lambası , LED'li 24 VAC /DC & 220 VAC		Yeşil	NP8-D/3	21.75	10	YENİ
Sinyal Lambası , LED'li 24 VAC /DC & 220 VAC		Kırmızı	NP8-D/4	21.75	10	YENİ
Sinyal Lambası , LED'li 24 VAC /DC & 220 VAC		Sarı	NP8-D/5	21.75	10	YENİ
Sinyal Lambası , LED'li 24 VAC /DC & 220 VAC		Mavi	NP8-D/6	21.75	10	YENİ

LED'li Işıklı Buzer

Ürün Tanımı 220/380 V AC	Renk	Sipariş Kodu	Fiyat (TL)	Min. Sipariş	
Kesintili Çalışma AC/DC 24 V, 230V A	Kırmızı	NFM1-22/F	24.28	10	YENİ
Sürekli Çalışma AC/DC 24 V, 230V A	Kırmızı	NFM1-22/L	24.28	10	YENİ
Kesintili Çalışma ve Flaş AC/DC 24 V, 230V A	Kırmızı	NFM1-22/FS	24.28	10	YENİ
Sürekli Işık ve Çalışma AC/DC 24 V, 230V A	Kırmızı	NFM1-22/LC	24.28	10	YENİ